

8006 NEW DEPARTURE

Deep groove ball bearings

TYPE: Ball bearings, Radial ball bearings, Single row, Without flange, Felt seal on one side, wide inner ring

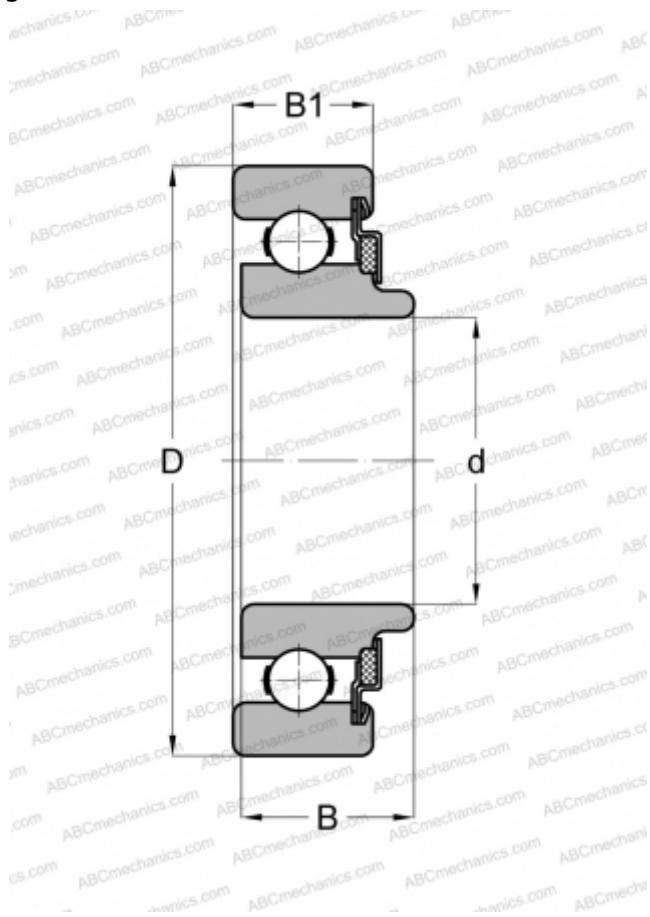

Technical specification

DIMENSIONS, MM

d	6,000
D	24,000
B	10,312
B1	8,001

WEIGHT, KG

0,022

MANUFACTURER

[NEW DEPARTURE](#)