

8500 NEW DEPARTURE

Deep groove ball bearings

TYPE: Ball bearings, Radial ball bearings, Single row, Without flange, Felt seal on one side, wide inner ring

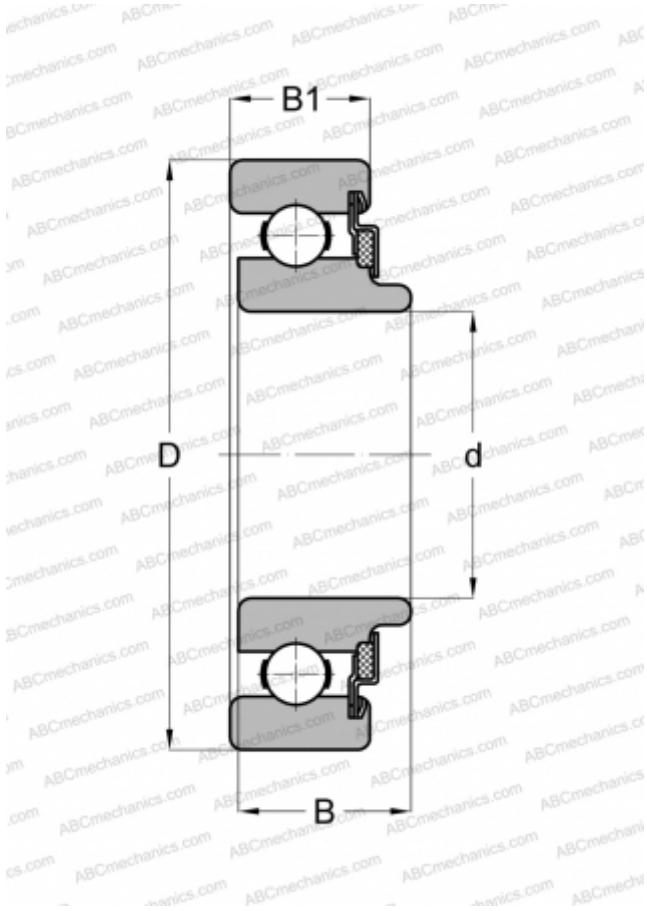

Technical specification

DIMENSIONS, MM

d	10,000
D	30,000
B	12,700
B1	8,992

WEIGHT, KG

0,035

MANUFACTURER

[NEW DEPARTURE](#)