

## 8501 NEW DEPARTURE

Deep groove ball bearings

TYPE: Ball bearings, Radial ball bearings, Single row, Without flange, Felt seal on one side, wide inner ring

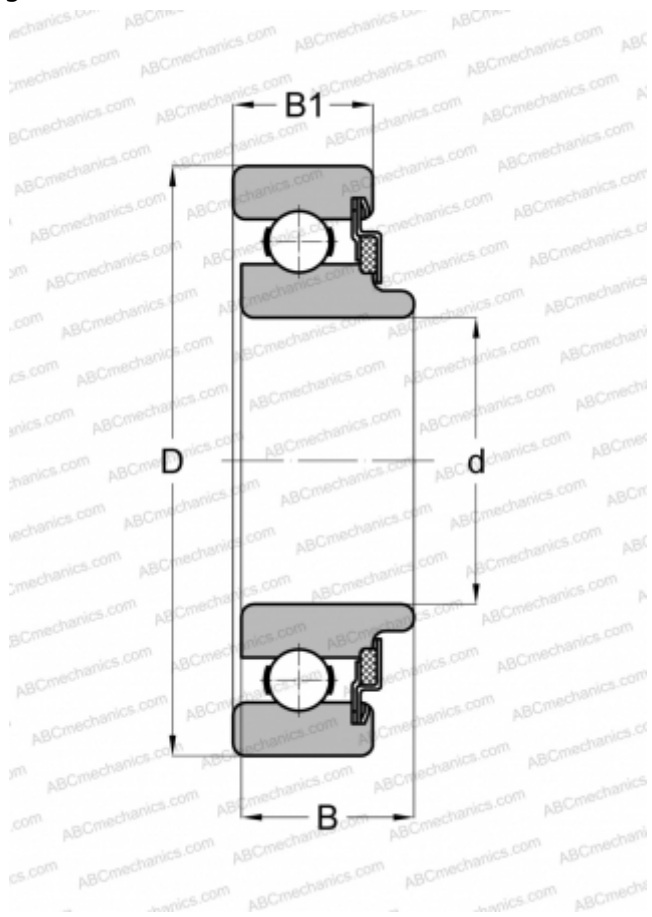

### Technical specification

#### DIMENSIONS, MM

d	12,000
D	32,000
B	12,700
B1	10,008

#### WEIGHT, KG

0,044

#### MANUFACTURER

[NEW DEPARTURE](#)