

8013 NEW DEPARTURE

Deep groove ball bearings

TYPE: Ball bearings, Radial ball bearings, Single row, Without flange, Felt seal on one side, wide inner ring

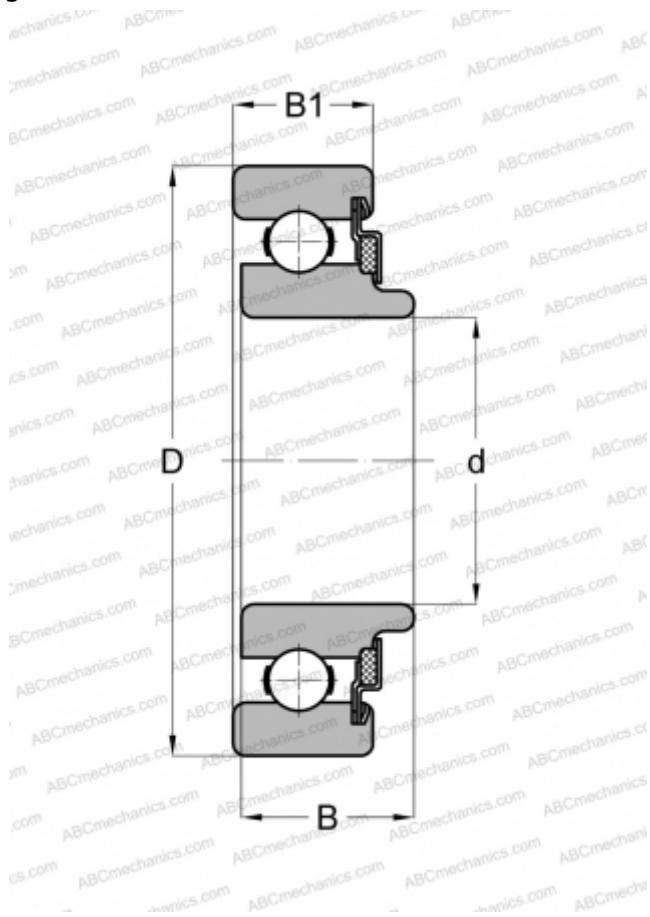

Technical specification

DIMENSIONS, MM

d	13,000
D	32,000
B	12,700
B1	10,008

WEIGHT, KG

0,042

MANUFACTURER

[NEW DEPARTURE](#)