

8503 NEW DEPARTURE

Deep groove ball bearings

TYPE: Ball bearings, Radial ball bearings, Single row, Without flange, Felt seal on one side, wide inner ring

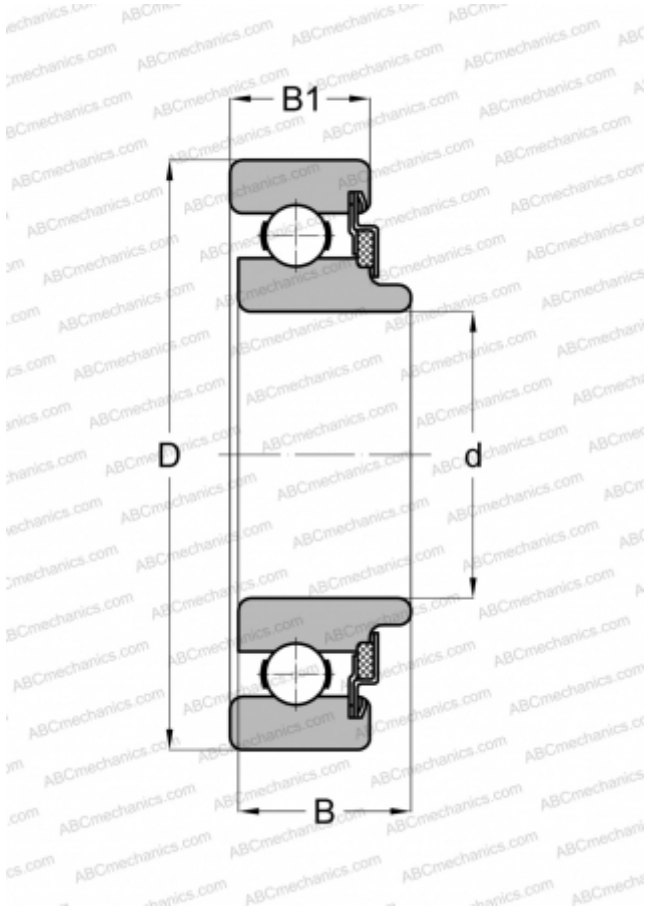

Technical specification

DIMENSIONS, MM

d	17,000
D	40,000
B	14,300
B1	11,989

WEIGHT, KG

0,070

MANUFACTURER

[NEW DEPARTURE](#)