

8505 NEW DEPARTURE

Deep groove ball bearings

TYPE: Ball bearings, Radial ball bearings, Single row, Without flange, Felt seal on one side, wide inner ring

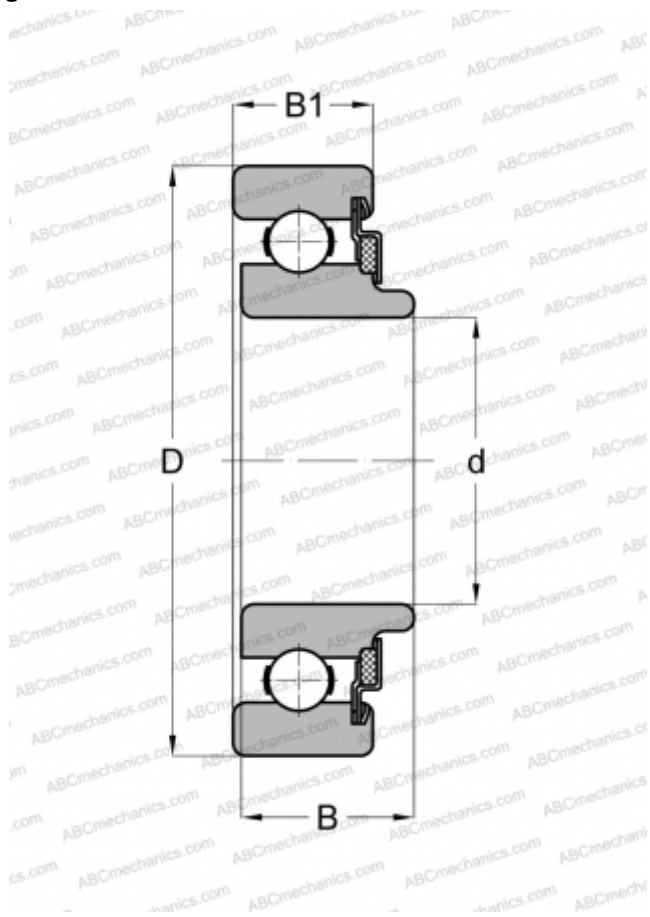

Technical specification

DIMENSIONS, MM

d	25,000
D	52,000
B	15,875
B1	15,011

WEIGHT, KG

0,132

MANUFACTURER

[NEW DEPARTURE](#)