

8602 NEW DEPARTURE

Deep groove ball bearings

TYPE: Ball bearings, Radial ball bearings, Single row, Without flange, Felt seal on one side, wide inner ring

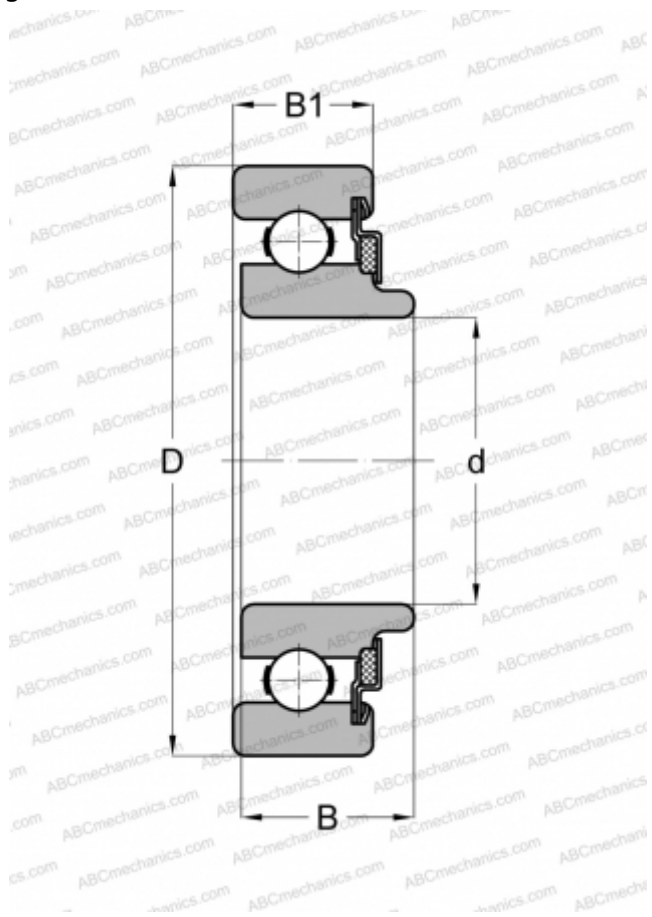

Technical specification

DIMENSIONS, MM

d	15,000
D	42,000
B	15,011
B1	13,005

WEIGHT, KG

0,086

MANUFACTURER

[NEW DEPARTURE](#)