

8606 NEW DEPARTURE

Deep groove ball bearings

TYPE: Ball bearings, Radial ball bearings, Single row, Without flange, Felt seal on one side, wide inner ring

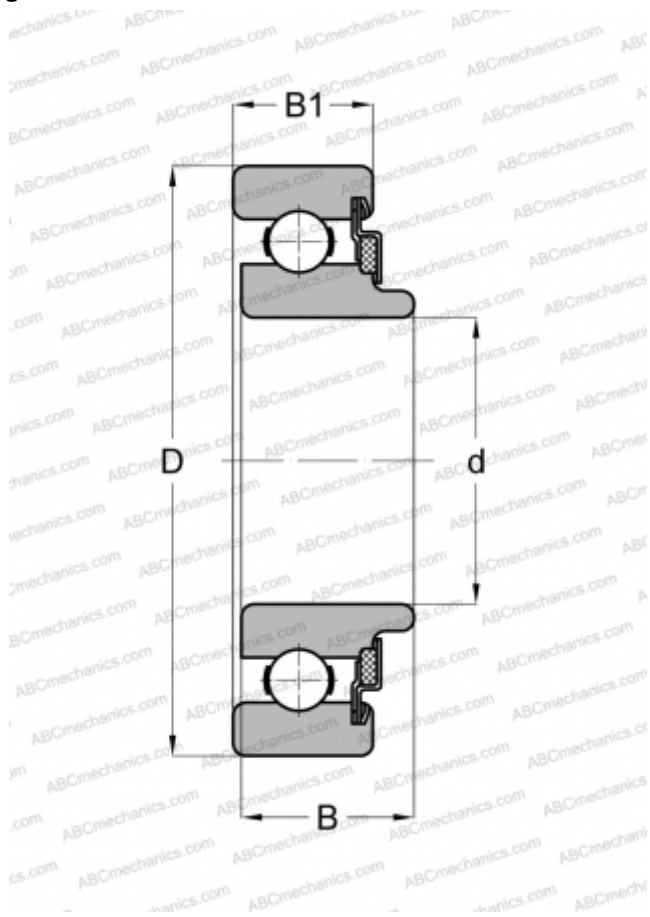

Technical specification

DIMENSIONS, MM

d	30,000
D	72,000
B	23,012
B1	18,999

WEIGHT, KG

0,513

MANUFACTURER

[NEW DEPARTURE](#)