

## 8607 NEW DEPARTURE

Deep groove ball bearings

TYPE: Ball bearings, Radial ball bearings, Single row, Without flange, Felt seal on one side, wide inner ring

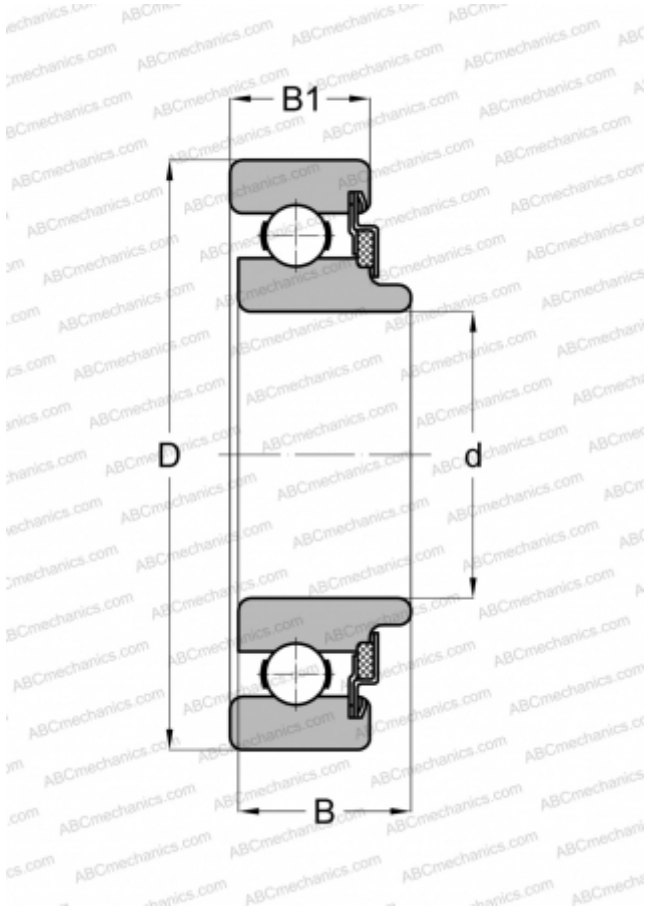

### Technical specification

#### DIMENSIONS, MM

d	35,000
D	80,000
B	24,994
B1	21,006

#### WEIGHT, KG

0,744

#### MANUFACTURER

[NEW DEPARTURE](#)