

8608 NEW DEPARTURE

Deep groove ball bearings

TYPE: Ball bearings, Radial ball bearings, Single row, Without flange, Felt seal on one side, wide inner ring

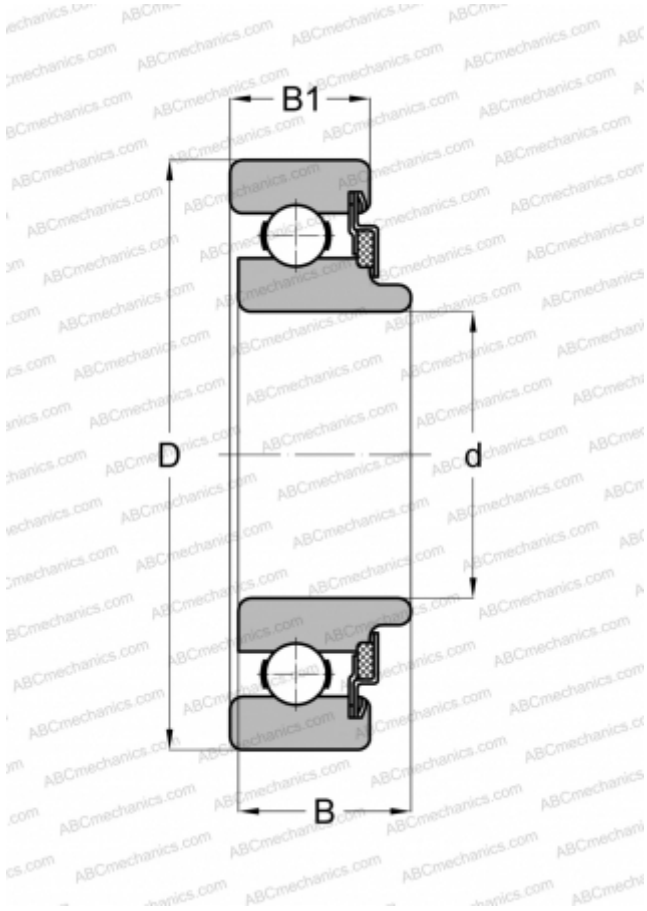

Technical specification

DIMENSIONS, MM

d	40,000
D	90,000
B	27,000
B1	23,012

WEIGHT, KG

0,934

MANUFACTURER

[NEW DEPARTURE](#)