

## 8007 NEW DEPARTURE

Deep groove ball bearings

TYPE: Ball bearings, Radial ball bearings, Single row, Without flange, Felt seal on one side, shield on second side, wide inner ring

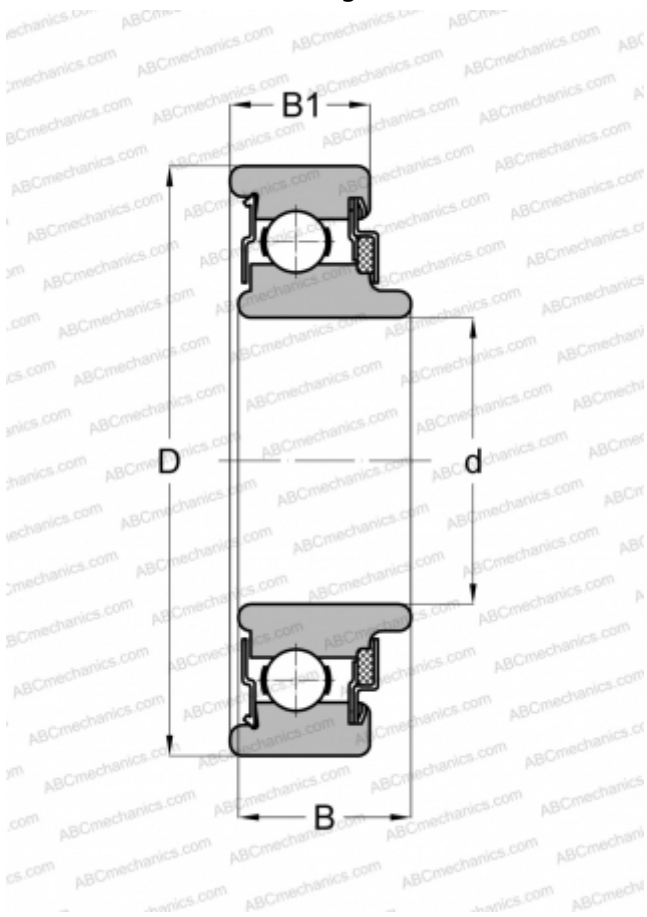

### Technical specification

#### DIMENSIONS, MM

d	7,000
D	24,000
B	10,312
B1	8,001

#### WEIGHT, KG

0,021

#### MANUFACTURER

[NEW DEPARTURE](#)