

## 8500 NEW DEPARTURE

Deep groove ball bearings

TYPE: Ball bearings, Radial ball bearings, Single row, Without flange, Felt seal on one side, shield on second side, wide inner ring

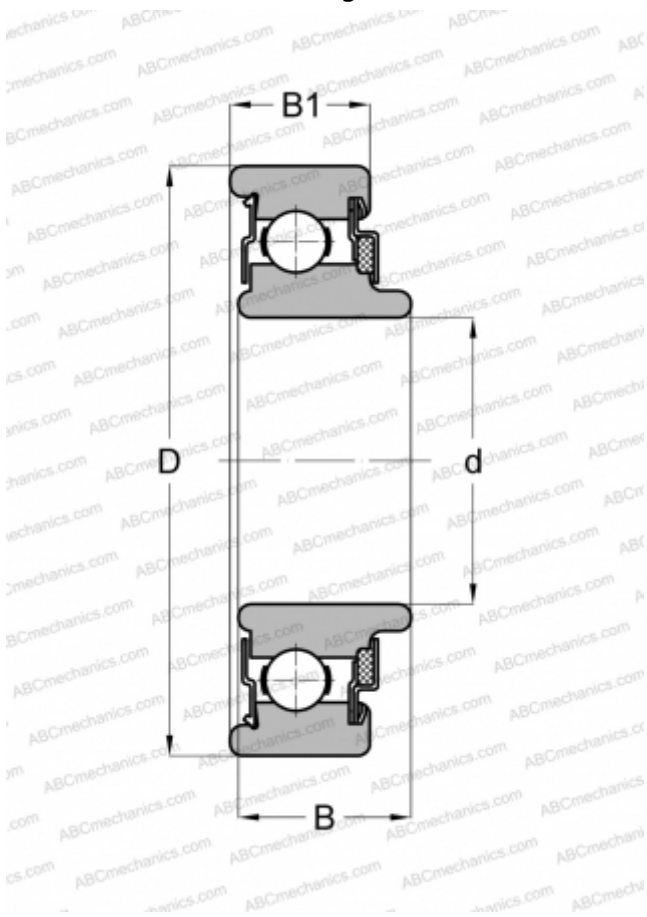

### Technical specification

#### DIMENSIONS, MM

d	10,000
D	30,000
B	12,700
B1	8,992

#### WEIGHT, KG

0,035

#### MANUFACTURER

[NEW DEPARTURE](#)