

## 8013 NEW DEPARTURE

Deep groove ball bearings

TYPE: Ball bearings, Radial ball bearings, Single row, Without flange, Felt seal on one side, shield on second side, wide inner ring

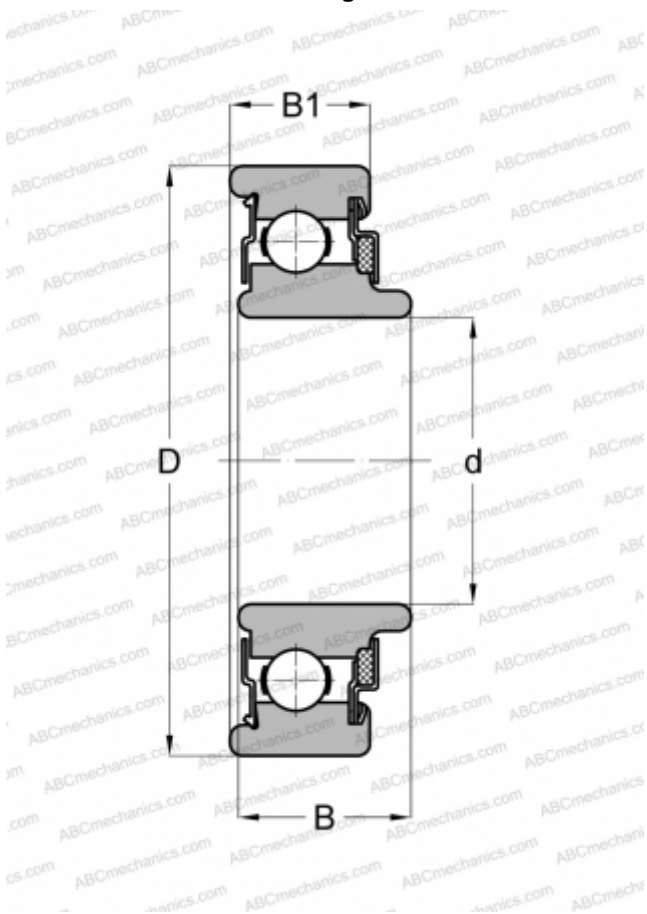

### Technical specification

#### DIMENSIONS, MM

d	13,000
D	32,000
B	12,700
B1	10,008

#### WEIGHT, KG

0,042

#### MANUFACTURER

[NEW DEPARTURE](#)