

8502 NEW DEPARTURE

Deep groove ball bearings

TYPE: Ball bearings, Radial ball bearings, Single row, Without flange, Felt seal on one side, shield on second side, wide inner ring

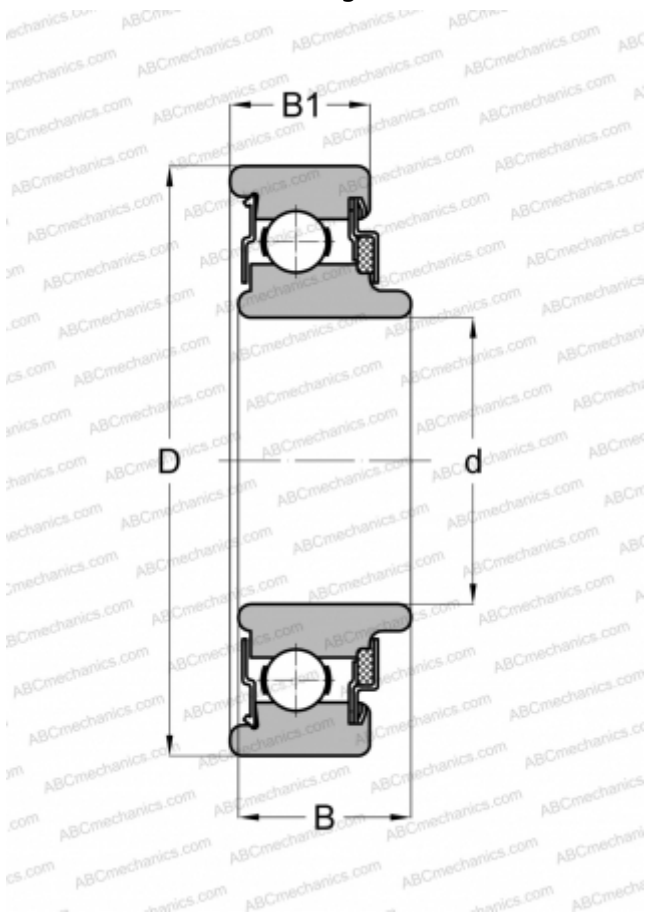

Technical specification

DIMENSIONS, MM

d	15,000
D	35,000
B	12,700
B1	10,998

WEIGHT, KG

0,049

MANUFACTURER

[NEW DEPARTURE](#)