

## 8506 NEW DEPARTURE

Deep groove ball bearings

TYPE: Ball bearings, Radial ball bearings, Single row, Without flange, Felt seal on one side, shield on second side, wide inner ring

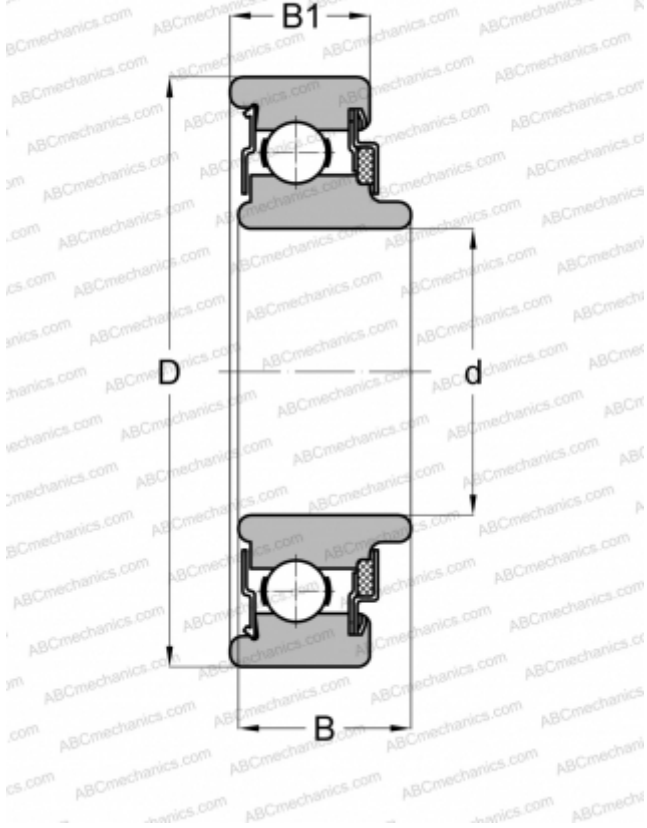

### Technical specification

#### DIMENSIONS, MM

d	30,000
D	62,000
B	19,990
B1	16,002

#### WEIGHT, KG

0,230

#### MANUFACTURER

[NEW DEPARTURE](#)