

## 8509 NEW DEPARTURE

Deep groove ball bearings

TYPE: Ball bearings, Radial ball bearings, Single row, Without flange, Felt seal on one side, shield on second side, wide inner ring

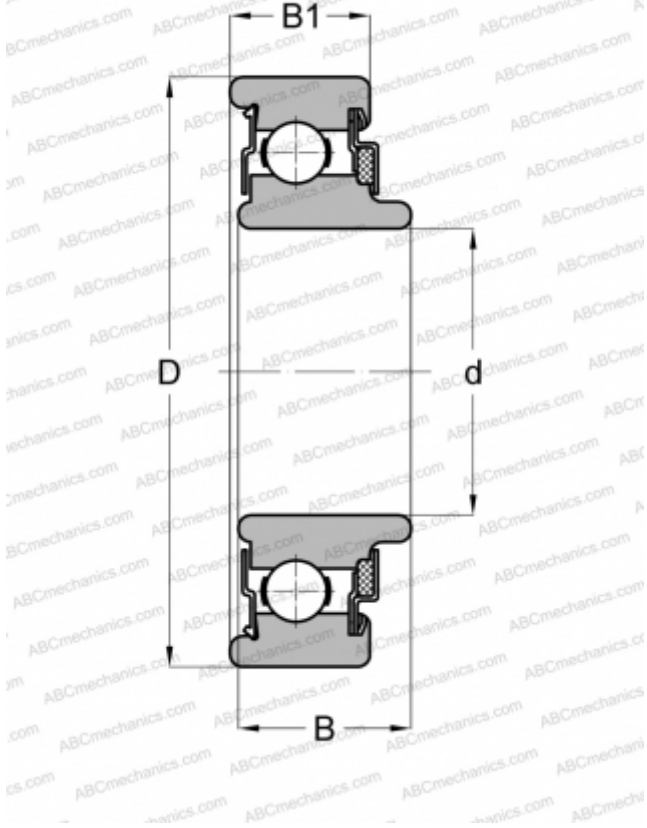

### Technical specification

#### DIMENSIONS, MM

d	45,000
D	85,000
B	24,003
B1	21,006

#### WEIGHT, KG

0,544

#### MANUFACTURER

[NEW DEPARTURE](#)