

8510 NEW DEPARTURE

Deep groove ball bearings

TYPE: Ball bearings, Radial ball bearings, Single row, Without flange, Felt seal on one side, shield on second side, wide inner ring

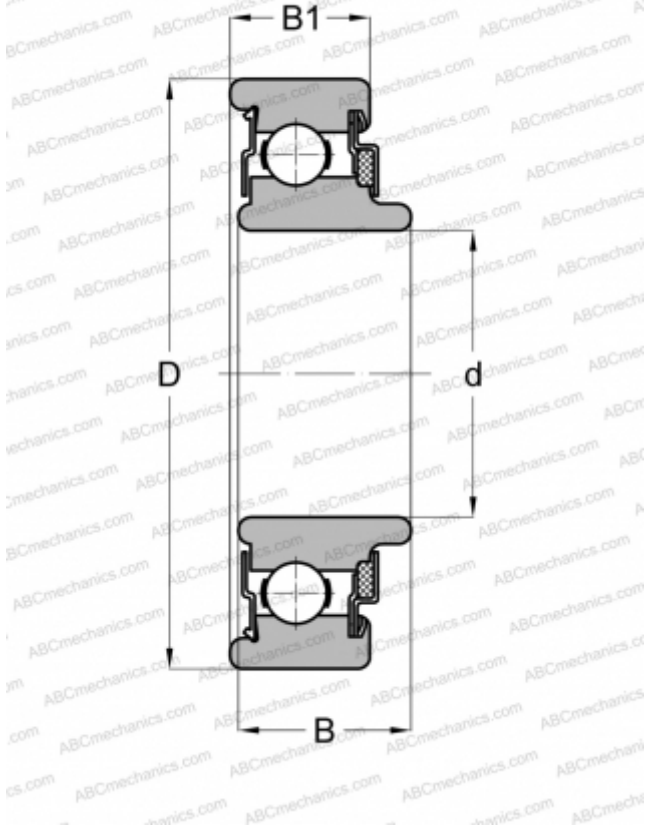

Technical specification

DIMENSIONS, MM

d	50,000
D	90,000
B	26,010
B1	21,996

WEIGHT, KG

0,590

MANUFACTURER

[NEW DEPARTURE](#)