

## 8512 NEW DEPARTURE

Deep groove ball bearings

TYPE: Ball bearings, Radial ball bearings, Single row, Without flange, Felt seal on one side, shield on second side, wide inner ring

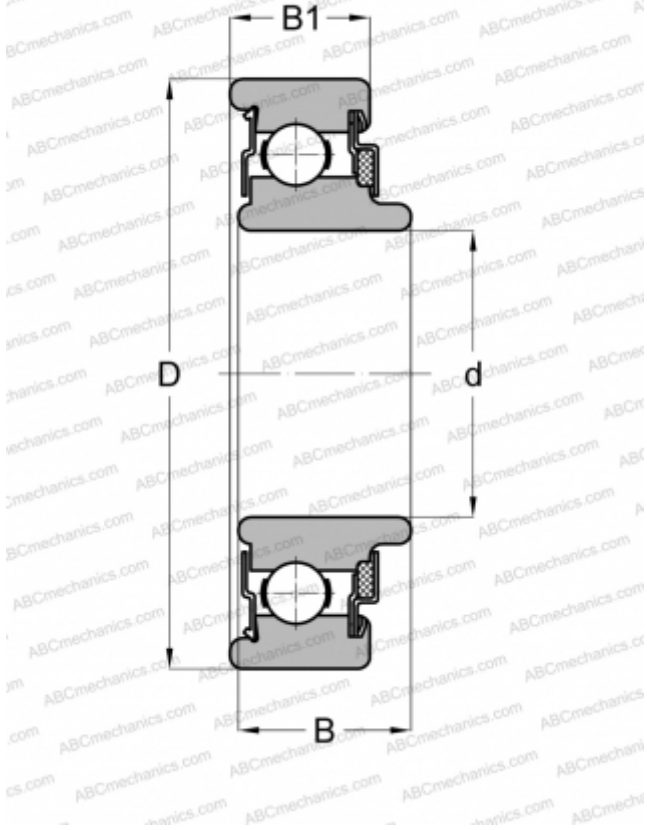

### Technical specification

#### DIMENSIONS, MM

d	60,000
D	110,000
B	29,007
B1	24,994

#### WEIGHT, KG

0,980

#### MANUFACTURER

[NEW DEPARTURE](#)