

8513 NEW DEPARTURE

Deep groove ball bearings

TYPE: Ball bearings, Radial ball bearings, Single row, Without flange, Felt seal on one side, shield on second side, wide inner ring

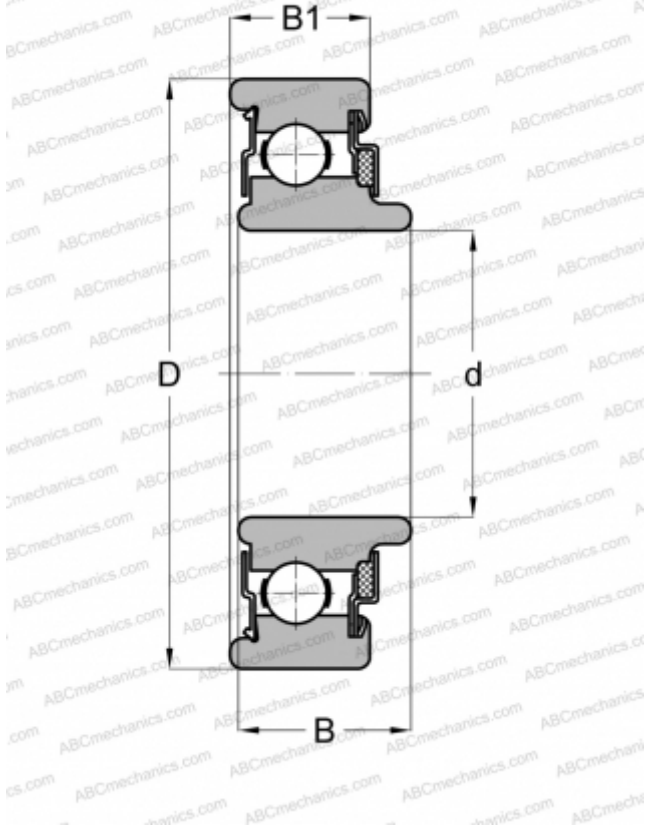

Technical specification

DIMENSIONS, MM

d	65,000
D	120,000
B	31,013
B1	26,010

WEIGHT, KG

1,279

MANUFACTURER

[NEW DEPARTURE](#)