

8514 NEW DEPARTURE

Deep groove ball bearings

TYPE: Ball bearings, Radial ball bearings, Single row, Without flange, Felt seal on one side, shield on second side, wide inner ring

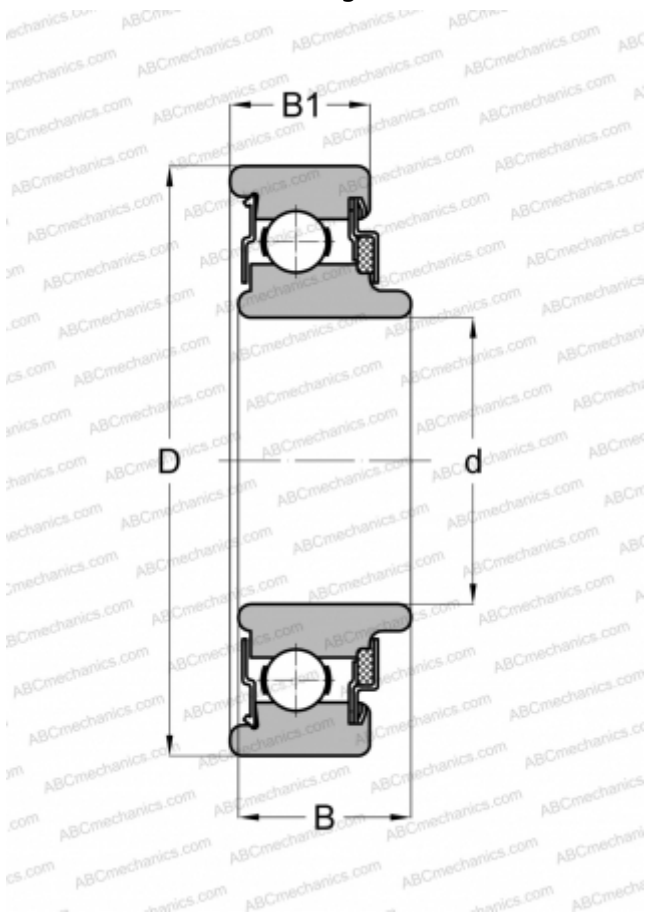

Technical specification

DIMENSIONS, MM

d	70,000
D	125,000
B	32,995
B1	27,991

WEIGHT, KG

1,397

MANUFACTURER

[NEW DEPARTURE](#)