

8603 NEW DEPARTURE

Deep groove ball bearings

TYPE: Ball bearings, Radial ball bearings, Single row, Without flange, Felt seal on one side, shield on second side, wide inner ring

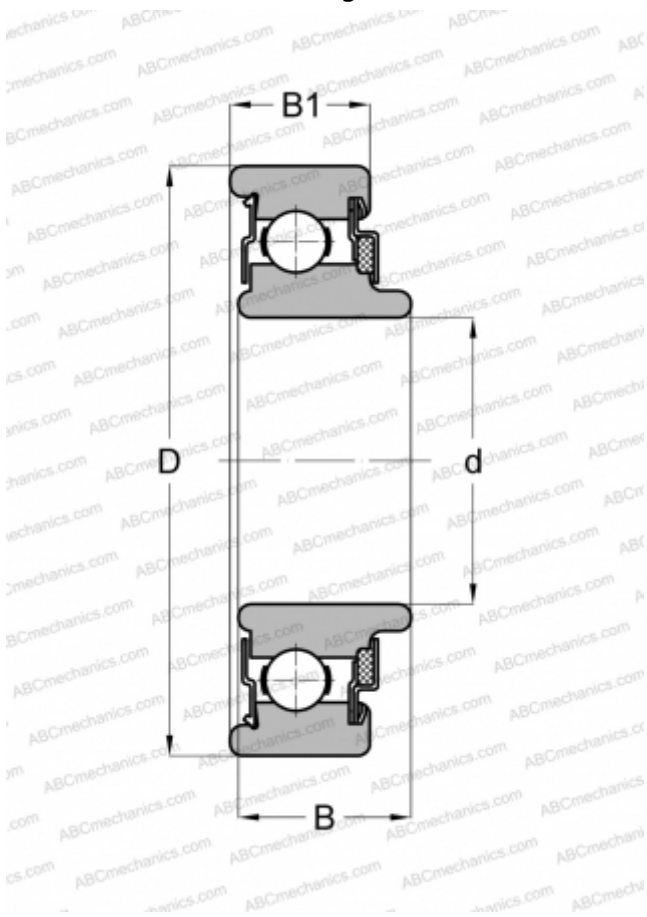

Technical specification

DIMENSIONS, MM

d	17,000
D	47,000
B	16,002
B1	13,995

WEIGHT, KG

0,095

MANUFACTURER

[NEW DEPARTURE](#)