

8605 NEW DEPARTURE

Deep groove ball bearings

TYPE: Ball bearings, Radial ball bearings, Single row, Without flange, Felt seal on one side, shield on second side, wide inner ring

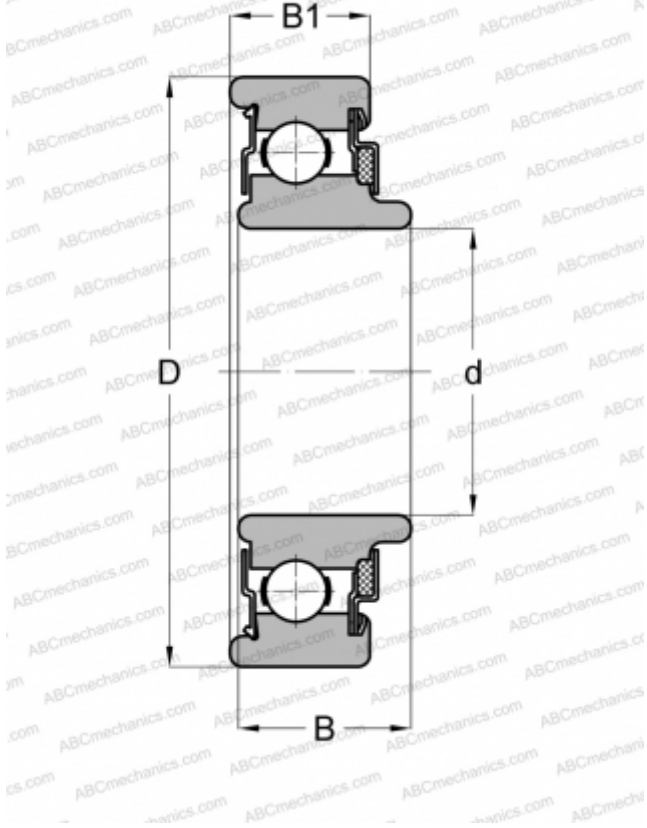

Technical specification

DIMENSIONS, MM

d	25,000
D	62,000
B	21,006
B1	16,993

WEIGHT, KG

0,354

MANUFACTURER

[NEW DEPARTURE](#)