

8607 NEW DEPARTURE

Deep groove ball bearings

TYPE: Ball bearings, Radial ball bearings, Single row, Without flange, Felt seal on one side, shield on second side, wide inner ring

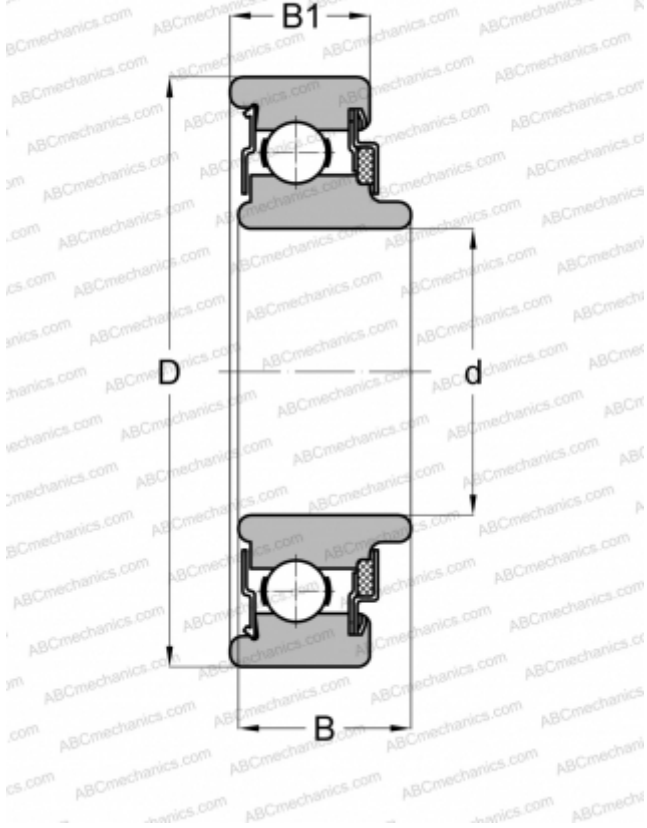

Technical specification

DIMENSIONS, MM

d	35,000
D	80,000
B	24,994
B1	21,006

WEIGHT, KG

0,744

MANUFACTURER

[NEW DEPARTURE](#)