

8609 NEW DEPARTURE

Deep groove ball bearings

TYPE: Ball bearings, Radial ball bearings, Single row, Without flange, Felt seal on one side, shield on second side, wide inner ring

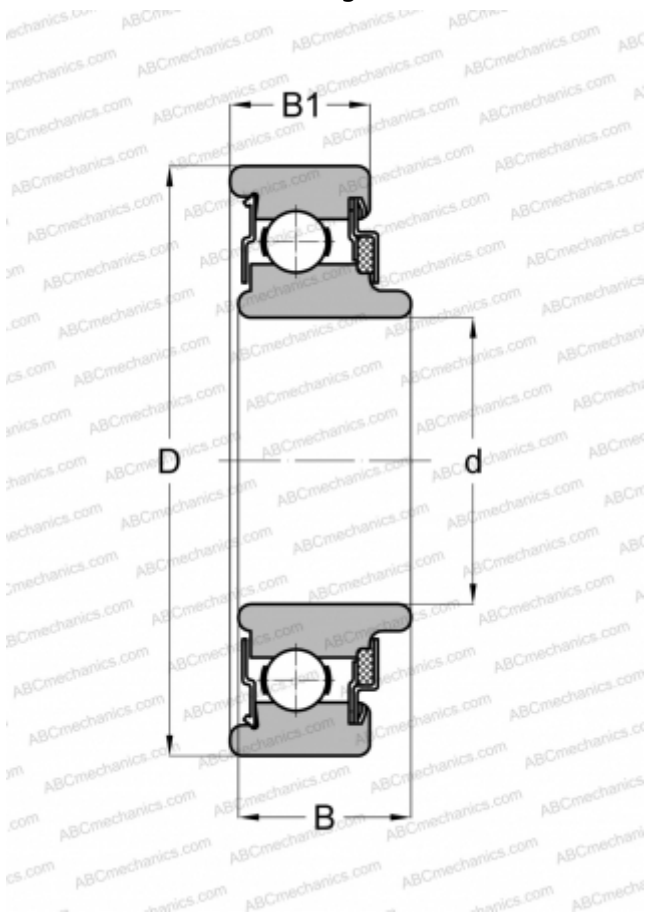

Technical specification

DIMENSIONS, MM

d	45,000
D	100,000
B	29,997
B1	24,994

WEIGHT, KG

1,361

MANUFACTURER

[NEW DEPARTURE](#)