

88037 NEW DEPARTURE

TYPE: Ball bearings, Radial ball bearings, Single row, Without flange, Felt seals on both side, wide inner ring

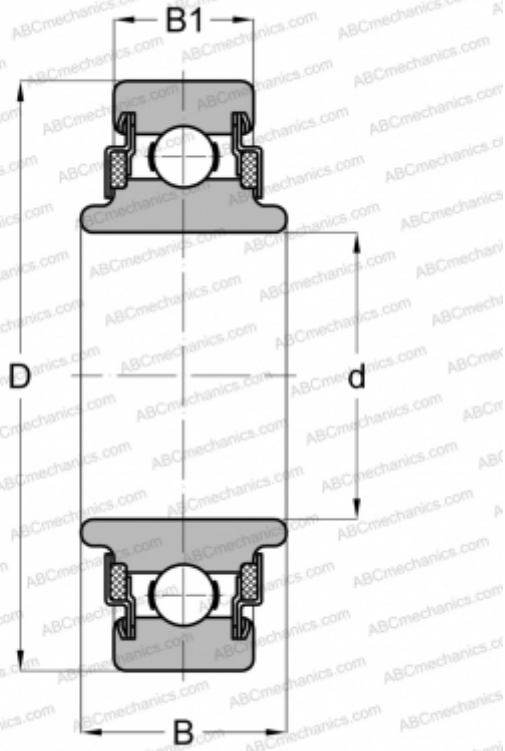

Technical specification

DIMENSIONS, MM

d	7,000
D	22,000
B	12,624
B1	8,001

WEIGHT, KG

0,020

MANUFACTURER

[NEW DEPARTURE](#)