

88016 NEW DEPARTURE

TYPE: Ball bearings, Radial ball bearings, Single row, Without flange, Felt seals on both side, wide inner ring

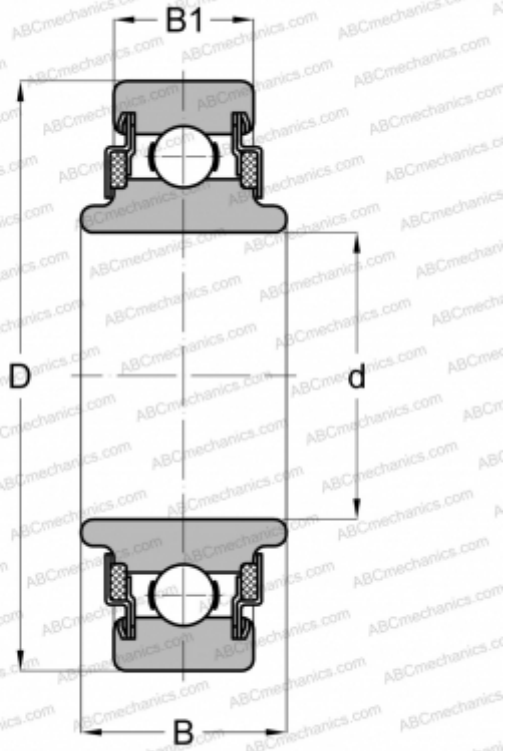

Technical specification

DIMENSIONS, MM

d	16,000
D	35,000
B	14,402
B1	10,998

WEIGHT, KG

0,052

MANUFACTURER

[NEW DEPARTURE](#)