

88508 NEW DEPARTURE

TYPE: Ball bearings, Radial ball bearings, Single row, Without flange, Felt seals on both side, wide inner ring

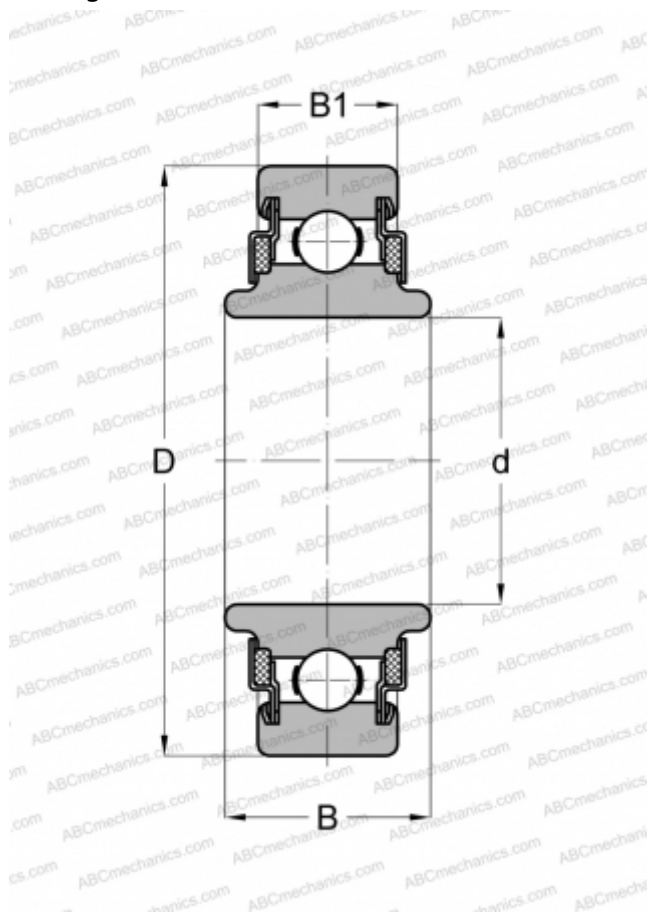

Technical specification

DIMENSIONS, MM

d	40,000
D	80,000
B	27,000
B1	21,006

WEIGHT, KG

0,535

MANUFACTURER

[NEW DEPARTURE](#)