

88602 NEW DEPARTURE

TYPE: Ball bearings, Radial ball bearings, Single row, Without flange, Felt seals on both side, wide inner ring

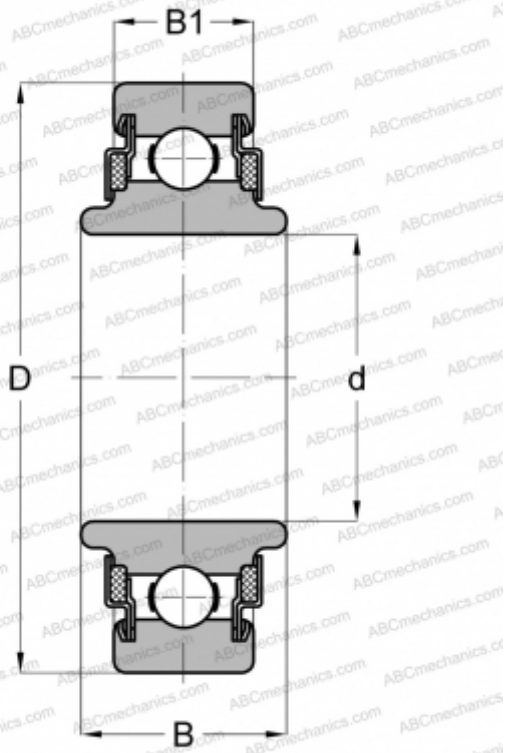

Technical specification

DIMENSIONS, MM

d	15,000
D	42,000
B	16,993
B1	13,005

WEIGHT, KG

0,113

MANUFACTURER

[NEW DEPARTURE](#)