

88606 NEW DEPARTURE

TYPE: Ball bearings, Radial ball bearings, Single row, Without flange, Felt seals on both side, wide inner ring

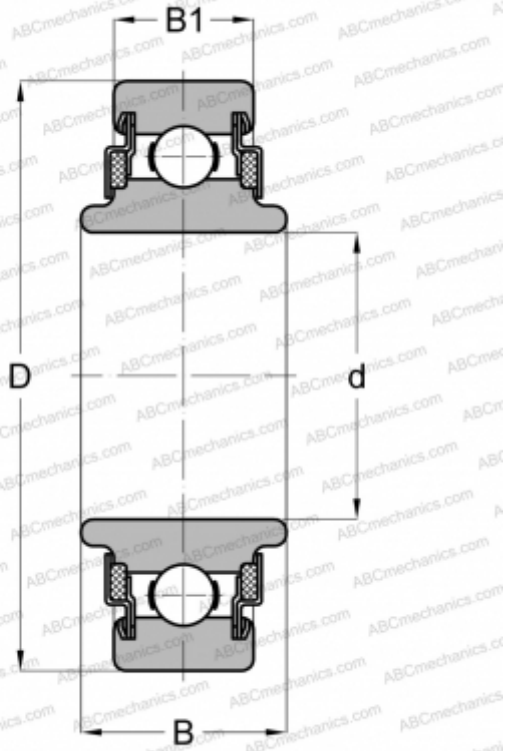

Technical specification

DIMENSIONS, MM

d	30,000
D	72,000
B	27,000
B1	18,999

WEIGHT, KG

0,513

MANUFACTURER

[NEW DEPARTURE](#)