

88608 NEW DEPARTURE

TYPE: Ball bearings, Radial ball bearings, Single row, Without flange, Felt seals on both side, wide inner ring

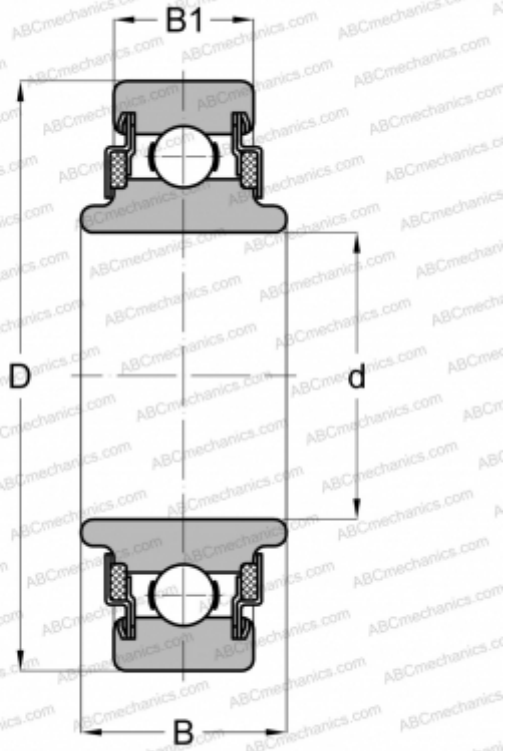

Technical specification

DIMENSIONS, MM

d	40,000
D	90,000
B	30,988
B1	23,012

WEIGHT, KG

0,937

MANUFACTURER

[NEW DEPARTURE](#)