

WC87008 NEW DEPARTURE

Deep groove ball bearings

TYPE: Ball bearings, Radial ball bearings, Single row, Without flange, Felt seal on one side, shield on second side

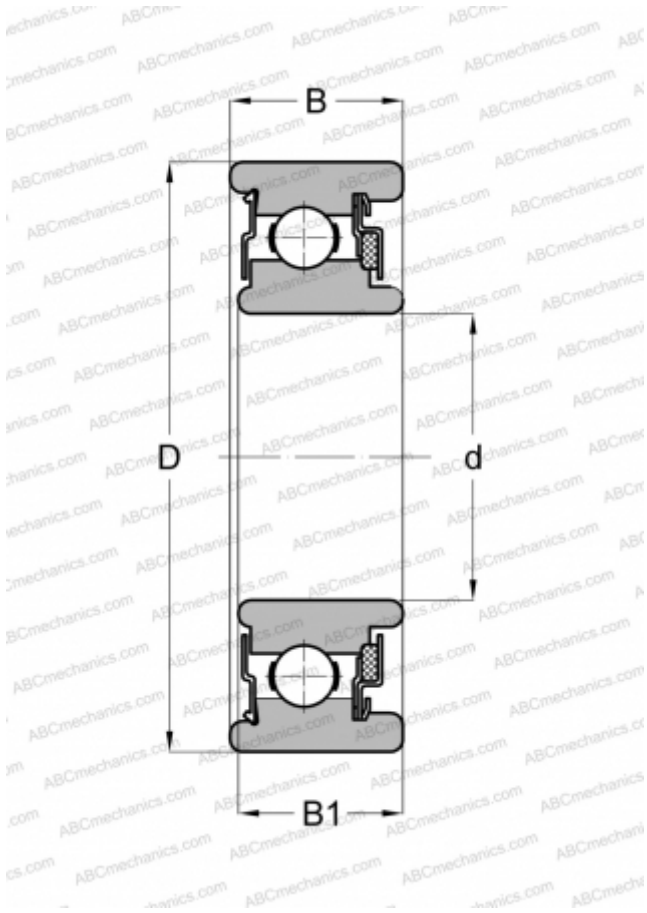

Technical specification

DIMENSIONS, MM

d	8,000
D	24,000
B	10,312
B1	10,312

WEIGHT, KG

0,021

MANUFACTURER

[NEW DEPARTURE](#)