

WC87013 NEW DEPARTURE

Deep groove ball bearings

TYPE: Ball bearings, Radial ball bearings, Single row, Without flange, Felt seal on one side, shield on second side

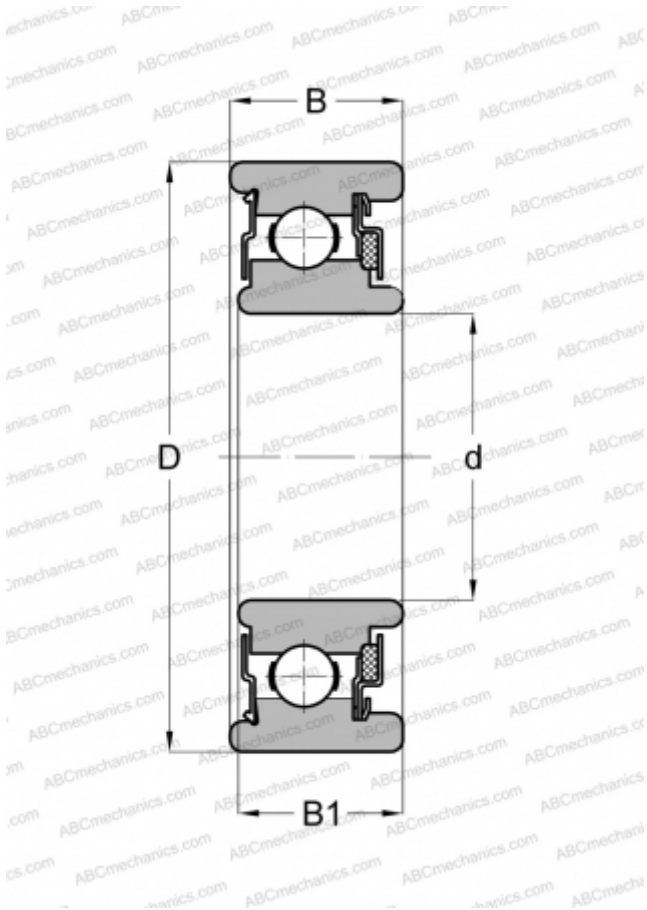

Technical specification

DIMENSIONS, MM

d	13,000
D	32,000
B	12,700
B1	12,192

WEIGHT, KG

0,041

MANUFACTURER

[NEW DEPARTURE](#)