

48506 NEW DEPARTURE

Deep groove ball bearings

TYPE: Ball bearings, Radial ball bearings, Single row, With snap ring groove, Snap ring, felt seals on one side, wide inner ring

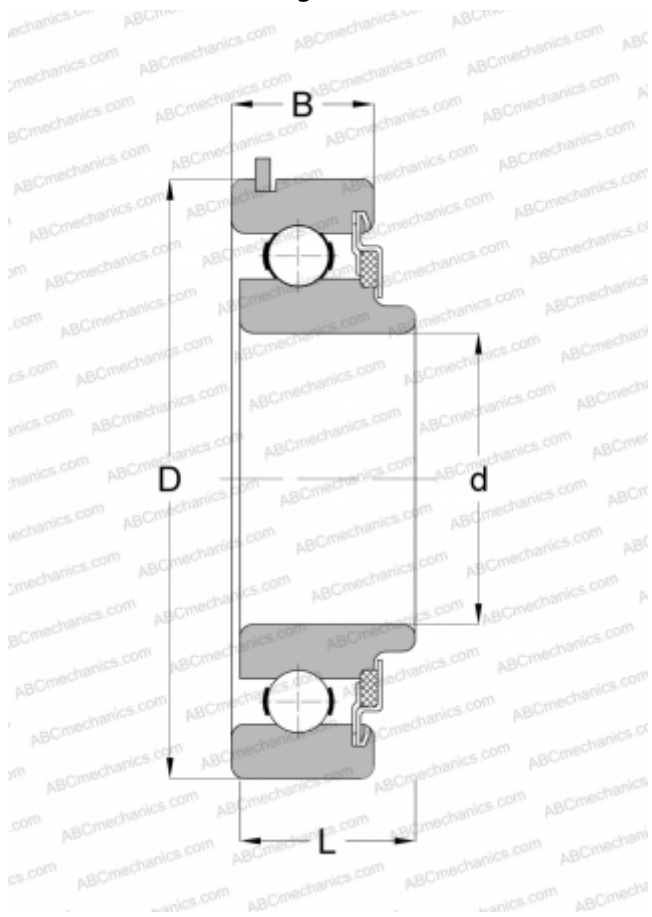

Technical specification

DIMENSIONS, MM

d	30,000
D	62,000
B	19,990
B1	16,002

WEIGHT, KG

0,230

MANUFACTURER

[NEW DEPARTURE](#)

INTERCHANGE

[ABC 8506NR](#)