

48507 NEW DEPARTURE

Deep groove ball bearings

TYPE: Ball bearings, Radial ball bearings, Single row, With snap ring groove, Snap ring, felt seals on one side, wide inner ring

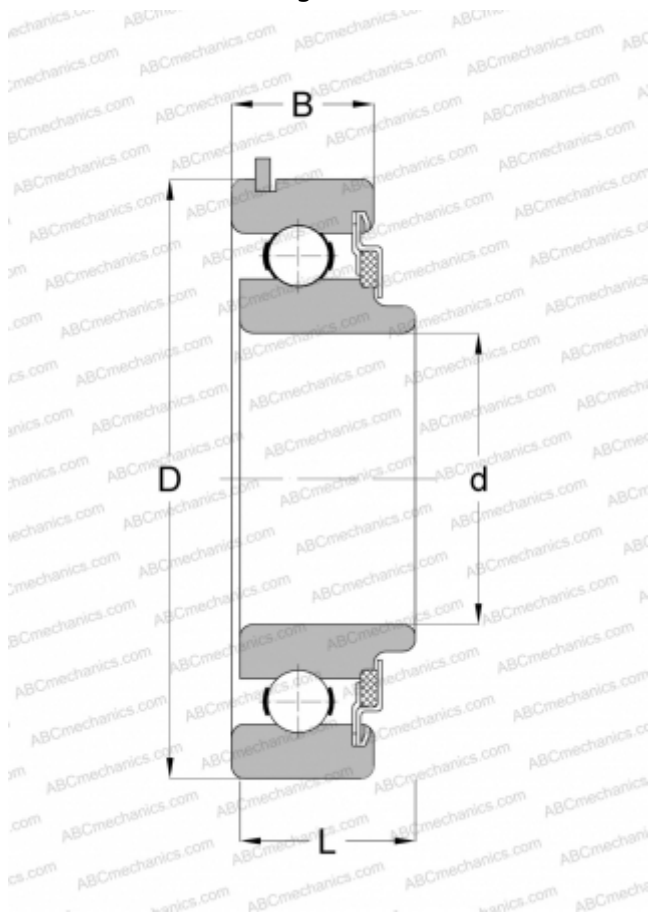

Technical specification

DIMENSIONS, MM

d	35,000
D	72,000
B	21,006
B1	16,993

WEIGHT, KG

0,321

MANUFACTURER

[NEW DEPARTURE](#)

INTERCHANGE

[ABC 8507NR](#)