

48607 NEW DEPARTURE

Deep groove ball bearings

TYPE: Ball bearings, Radial ball bearings, Single row, With snap ring groove, Snap ring, felt seals on one side, wide inner ring

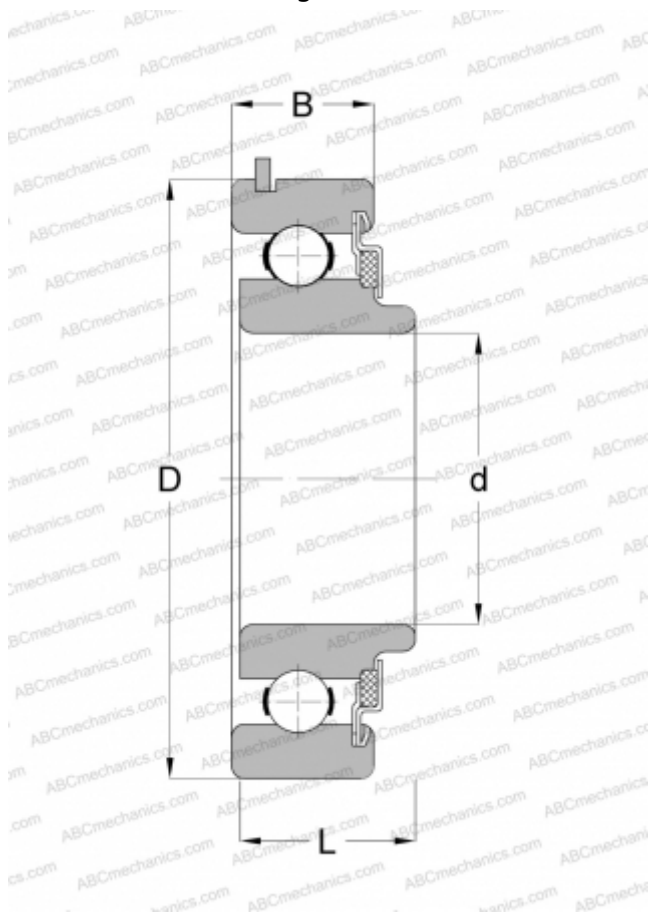

Technical specification

DIMENSIONS, MM

d	35,000
D	80,000
B	24,994
B1	21,006

WEIGHT, KG

0,744

MANUFACTURER

[NEW DEPARTURE](#)

INTERCHANGE

[ABC 8607NR](#)