

101774 FAG

Angular contact ball bearings

TYPE: Ball bearings, Angular contact ball bearing, Double row, Hub bearing (unit), FAG production, generation 2

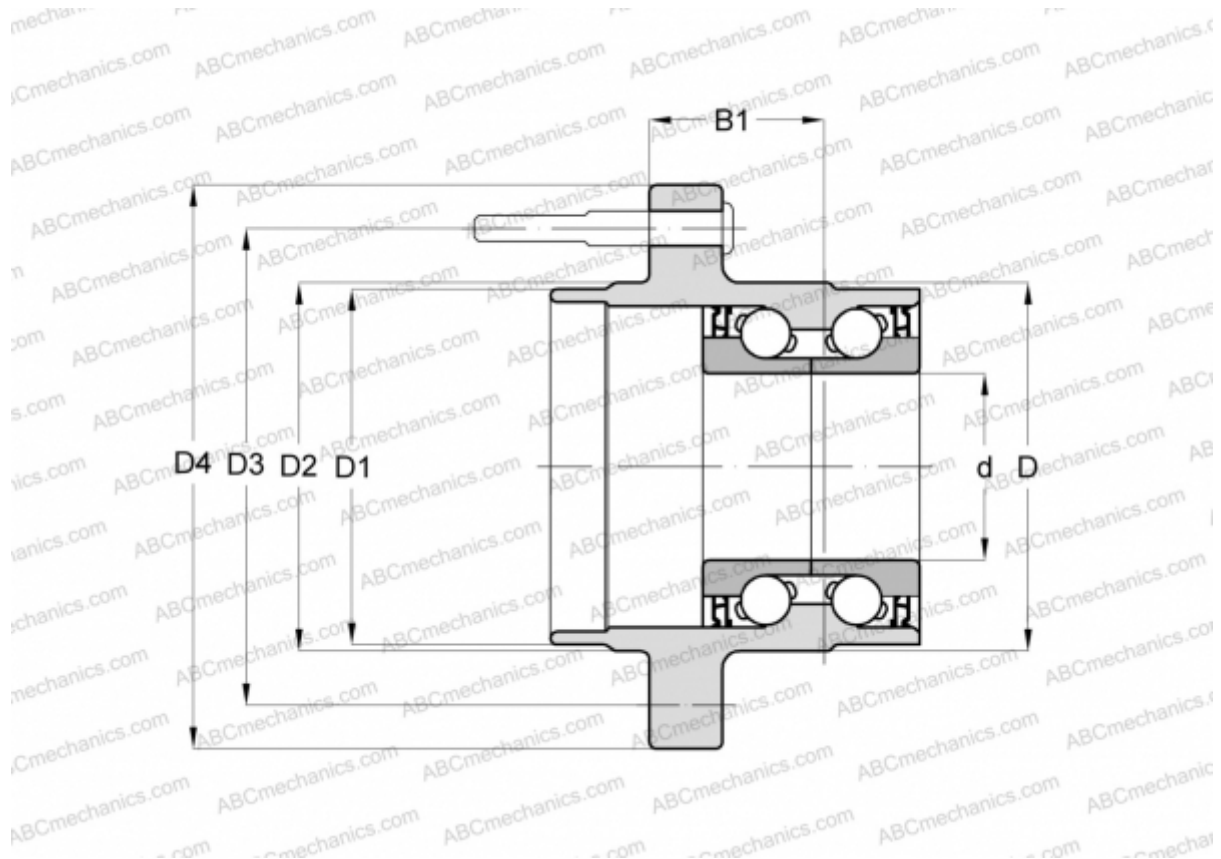

Technical specification

DIMENSIONS, MM

d	43,000
D	79,500
D1	72,200
D2	80,600
B1	55,000
T	120,000

MANUFACTURER

[FAG](#)