

101780 FAG

Angular contact ball bearings

TYPE: Ball bearings, Angular contact ball bearing, Double row, Hub bearing (unit), FAG production, generation 2

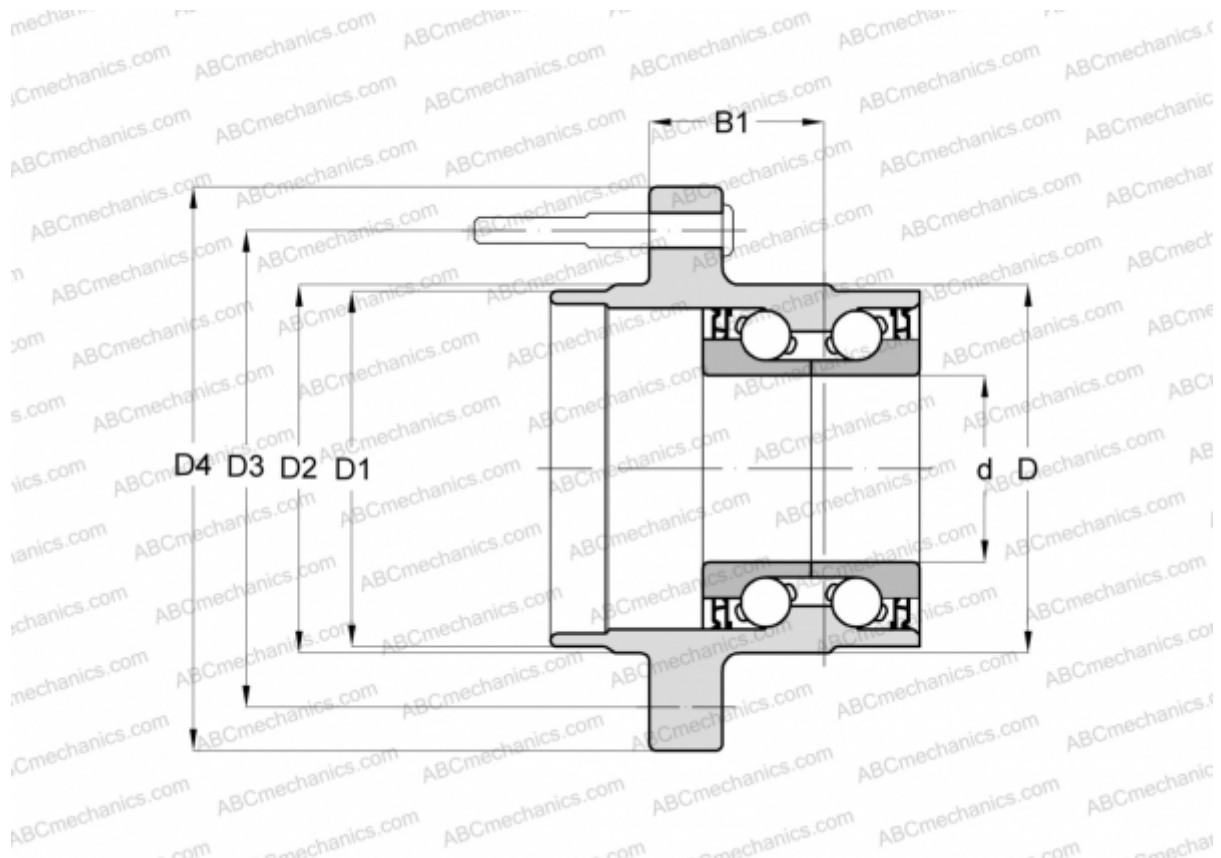

Technical specification

DIMENSIONS, MM

d	51,000
D	90,000
D1	90,000
D2	90,000
B1	47,000
T	106,000

MANUFACTURER

[FAG](#)