

101790 FAG

Angular contact ball bearings

TYPE: Ball bearings, Angular contact ball bearing, Double row, Hub bearing (unit), FAG production, generation 2

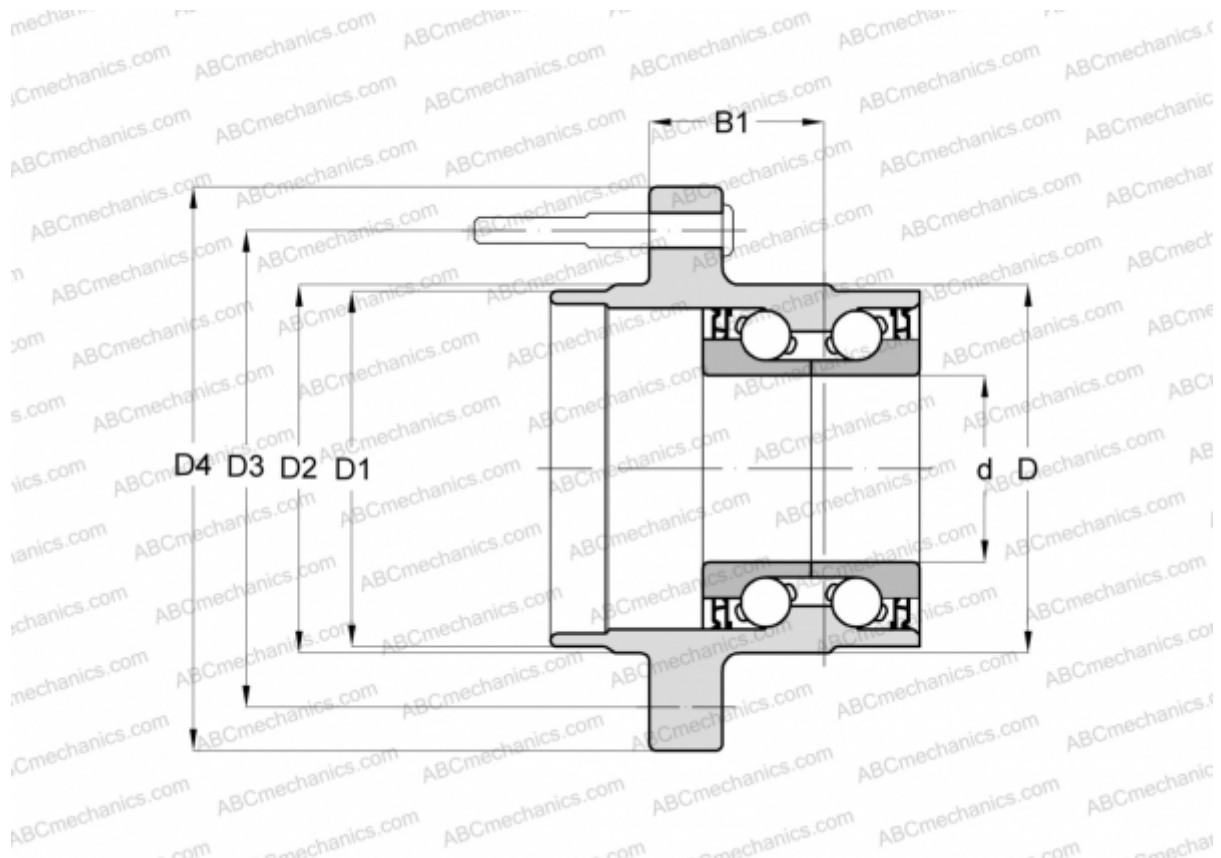

Technical specification

DIMENSIONS, MM

d	35,000
D	90,000
D1	67,000
D2	76,000
D3	114,300
D4	148,000
B1	56,200

MANUFACTURER

[FAG](#)