

102094 FAG

Angular contact ball bearings

TYPE: Ball bearings, Angular contact ball bearing, Double row, Hub bearing (unit), FAG production, generation 2

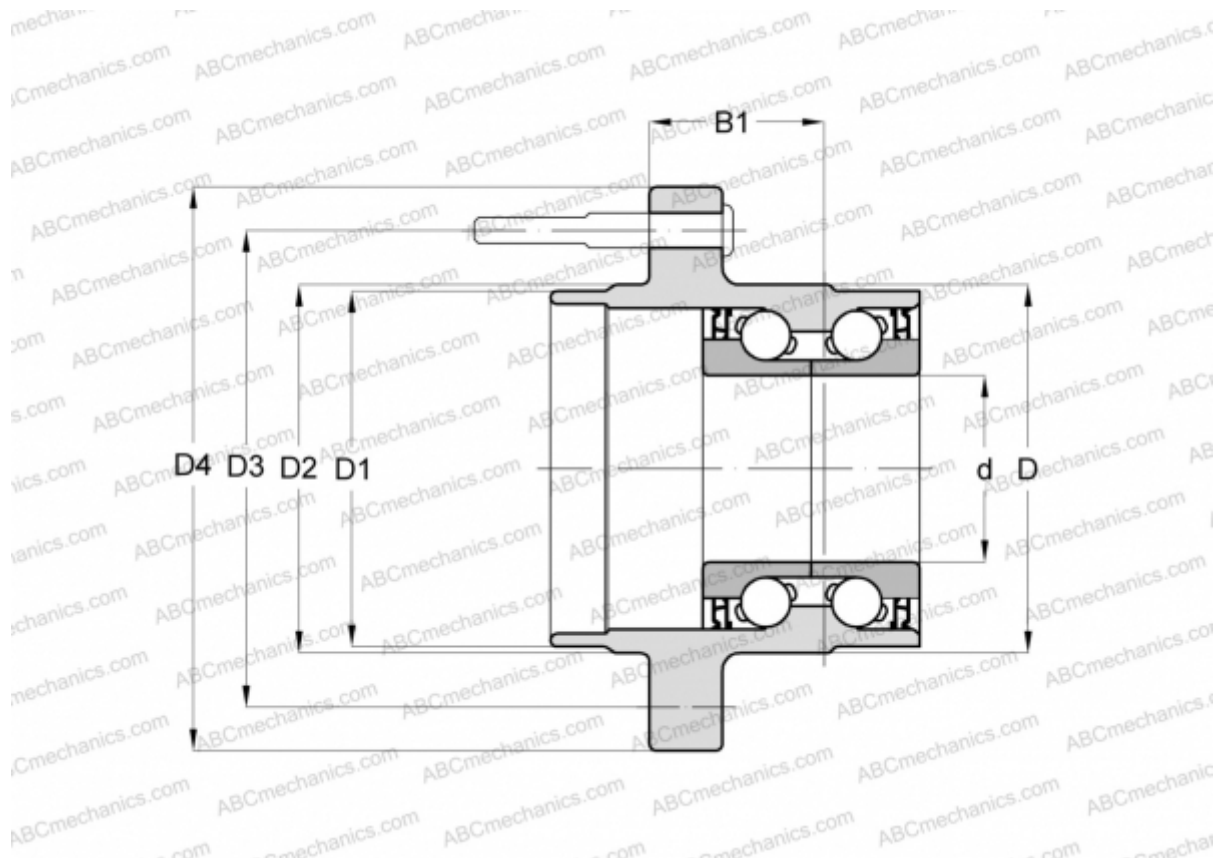

Technical specification

DIMENSIONS, MM

d	30,000
D	66,000
D1	58,000
D2	64,000
D3	114,300
D4	152,000
B1	56,000

MANUFACTURER

[FAG](#)