

102102 FAG

Angular contact ball bearings

TYPE: Ball bearings, Angular contact ball bearing, Double row, Hub bearing (unit), FAG production, generation 2

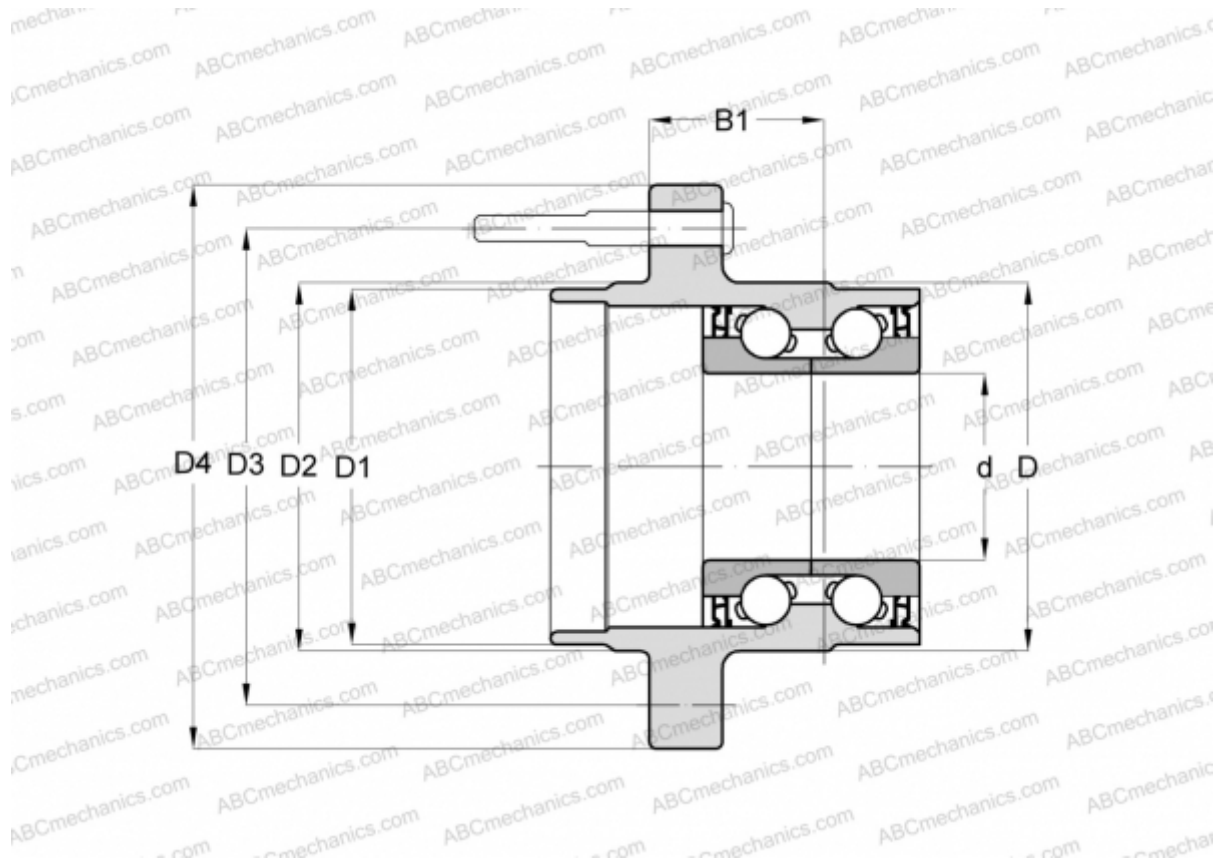

Technical specification

DIMENSIONS, MM

d	28,000
D	70,500
D1	56,900
D2	57,400
D3	100,000
D4	135,300
B1	49,400

MANUFACTURER

[FAG](#)