

102110 FAG

Angular contact ball bearings

TYPE: Ball bearings, Angular contact ball bearing, Double row, Hub bearing (unit), FAG production, generation 2

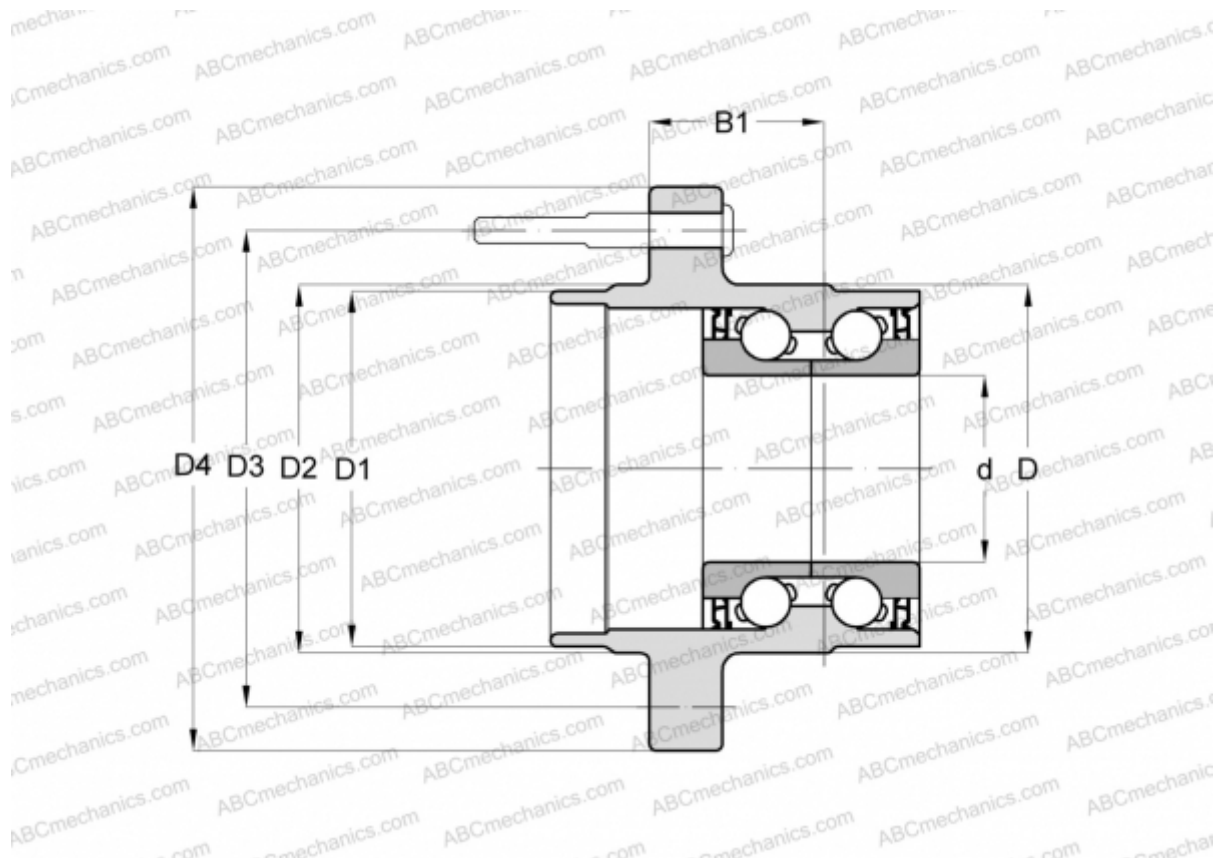

Technical specification

DIMENSIONS, MM

d	30,000
D	79,800
D1	56,000
D2	64,000
D3	100,000
D4	123,200
B1	56,500

MANUFACTURER

[FAG](#)