

102141 FAG

Angular contact ball bearings

TYPE: Ball bearings, Angular contact ball bearing, Double row, Hub bearing (unit), FAG production, generation 2

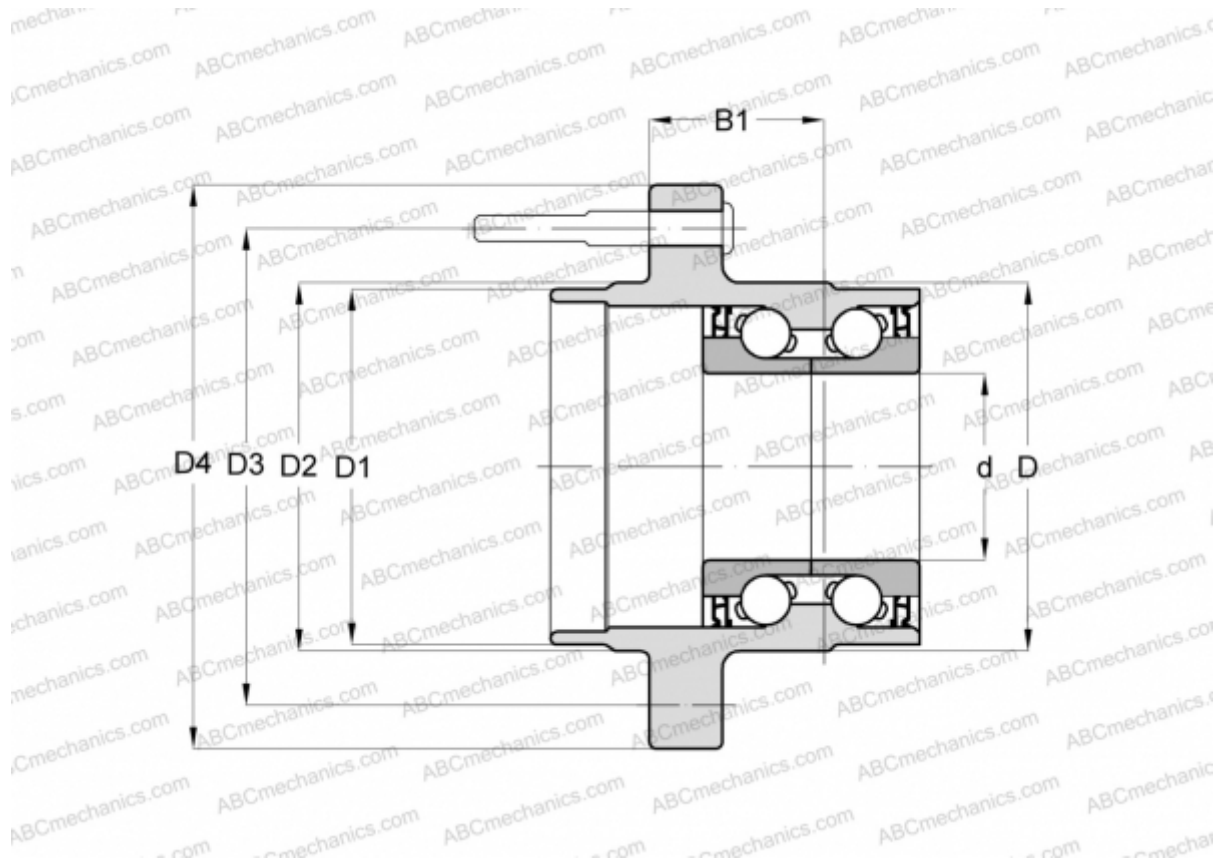

Technical specification

DIMENSIONS, MM

d	28,000
D	63,000
D1	59,900
D2	64,000
D3	114,300
D4	134,000
B1	49,450

MANUFACTURER

[FAG](#)