

102252 FAG

Angular contact ball bearings

TYPE: Ball bearings, Angular contact ball bearing, Double row, Hub bearing (unit), FAG production, generation 2

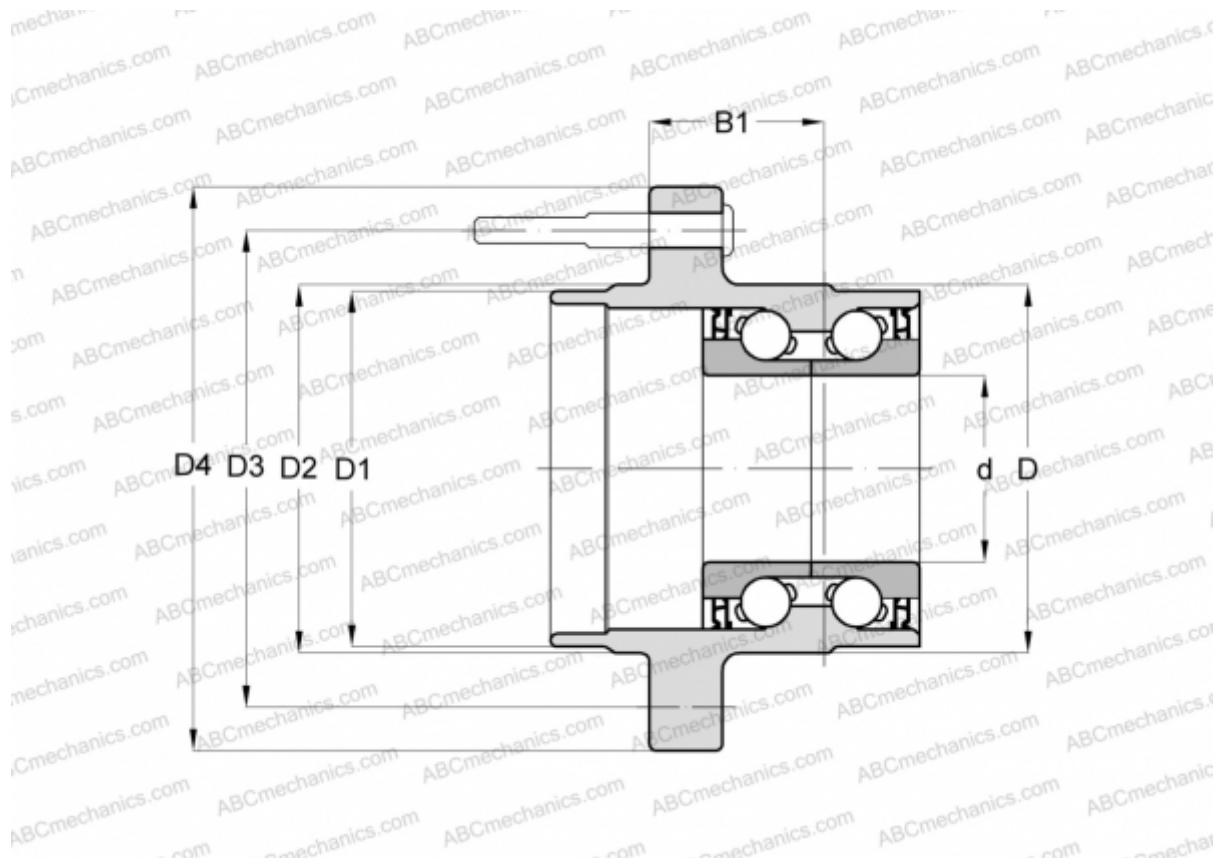

Technical specification

DIMENSIONS, MM

d	32,000
D	85,800
D1	67,000
D2	79,000
D3	114,300
D4	139,000
B1	50,500

MANUFACTURER

[FAG](#)