

102616 FAG

Angular contact ball bearings

TYPE: Ball bearings, Angular contact ball bearing, Double row, Hub bearing (unit), FAG production, generation 2

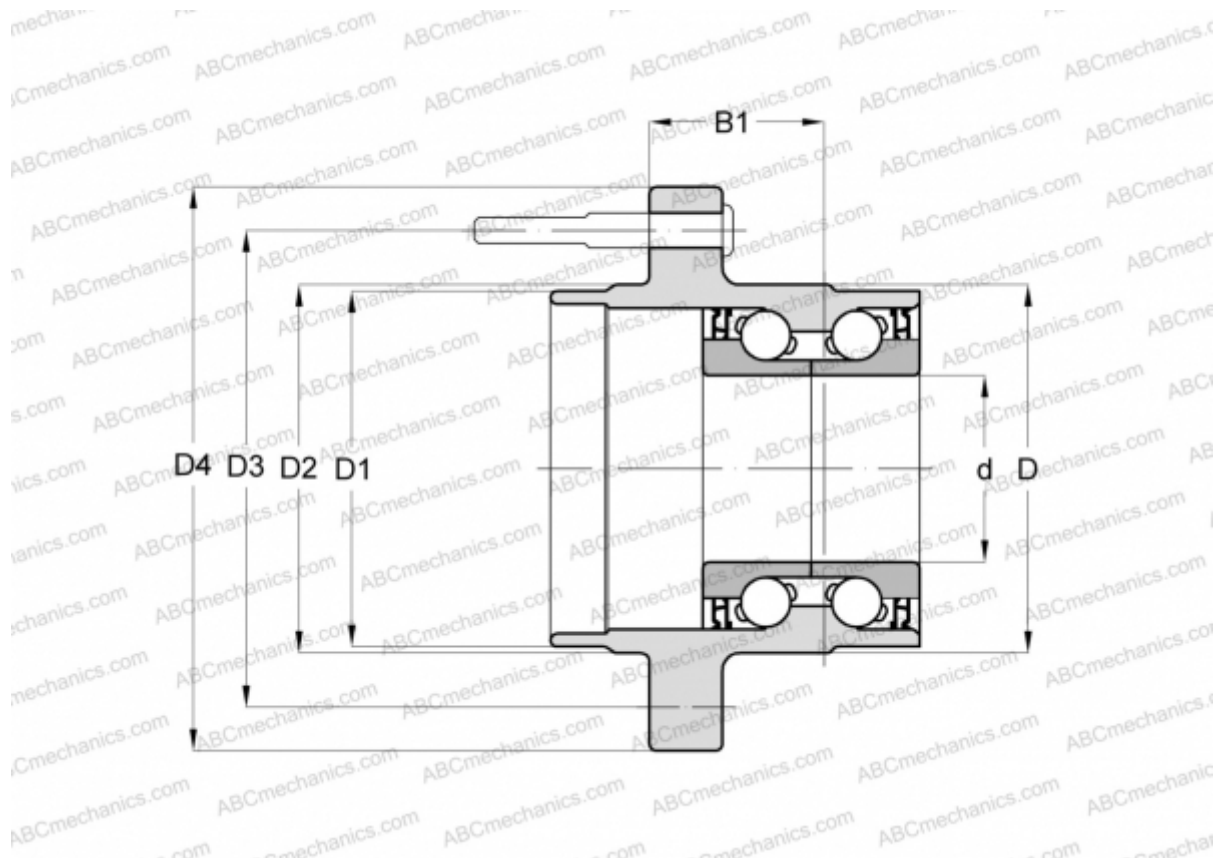

Technical specification

DIMENSIONS, MM

d	28,000
D	70,000
D1	56,500
D2	62,500
D3	100,000
D4	140,000
B1	50,500

MANUFACTURER

[FAG](#)