

## 805267 FAG

Angular contact ball bearings

TYPE: Ball bearings, Angular contact ball bearing, Double row, Hub bearing (unit), FAG production, generation 2

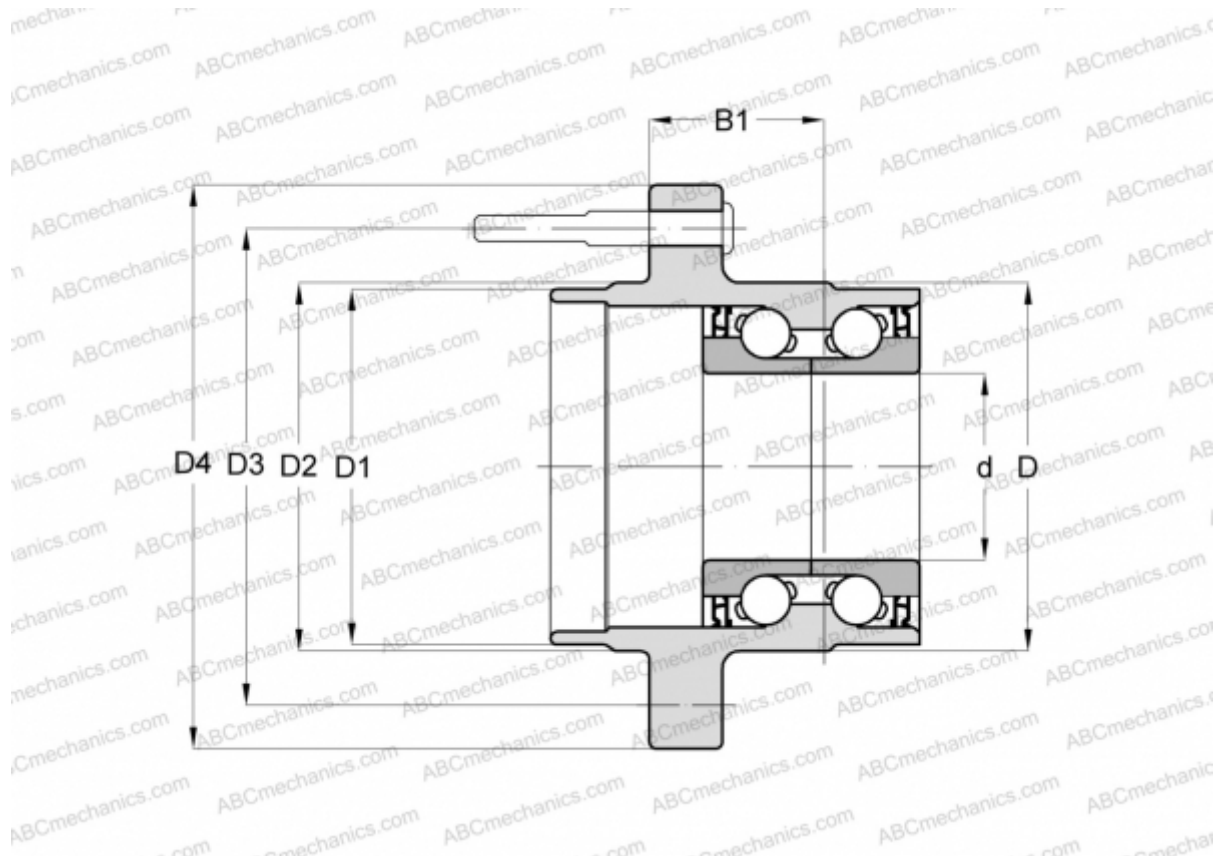

### Technical specification

#### DIMENSIONS, MM

d	30,000
D	65,000
D1	58,000
D2	59,000
D3	98,000
D4	117,000
B1	43,200

#### MANUFACTURER

[FAG](#)