

805349 FAG

Angular contact ball bearings

TYPE: Ball bearings, Angular contact ball bearing, Double row, Hub bearing (unit), FAG production, generation 2

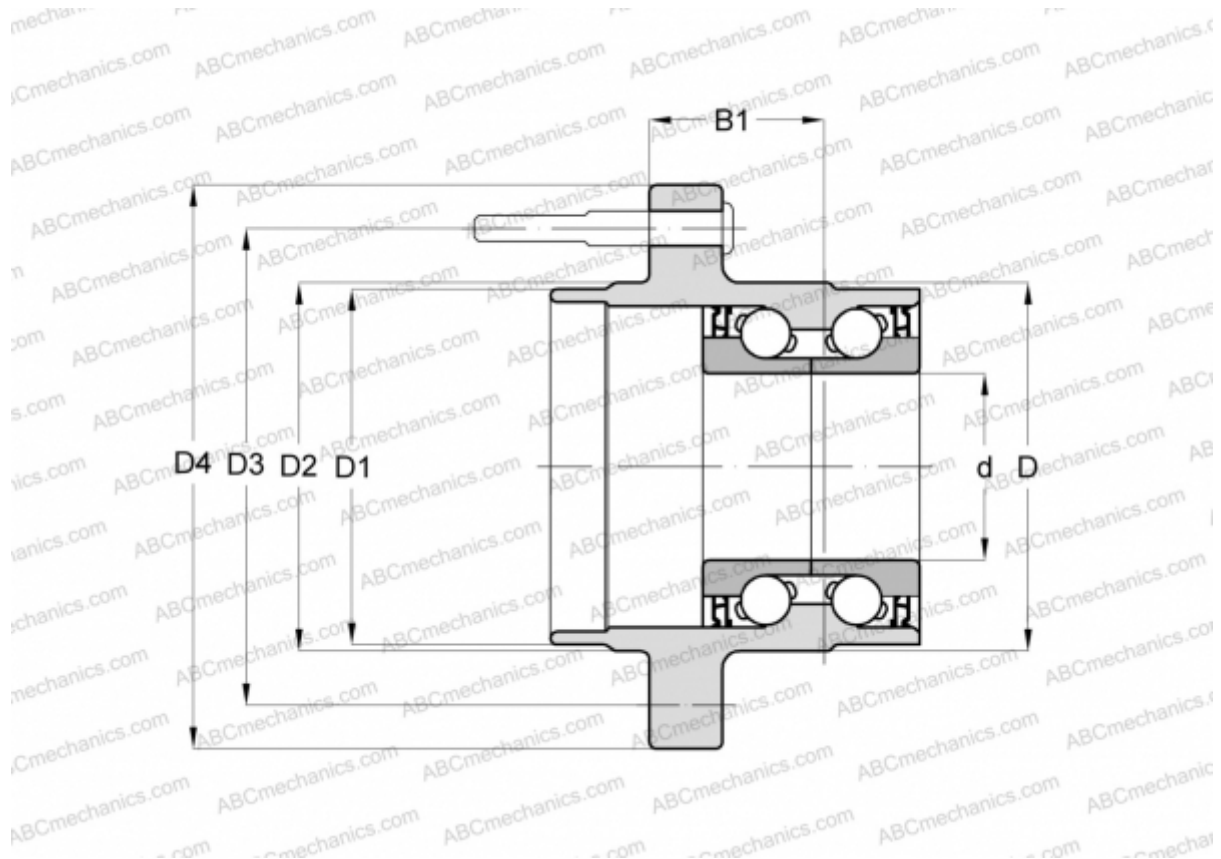

Technical specification

DIMENSIONS, MM

d	37,000
D	83,000
D1	72,492
D2	78,994
D3	119,888
D4	143,002
B1	46,000

MANUFACTURER

[FAG](#)