

## 805963 FAG

Angular contact ball bearings

TYPE: Ball bearings, Angular contact ball bearing, Double row, Hub bearing (unit), FAG production, generation 2

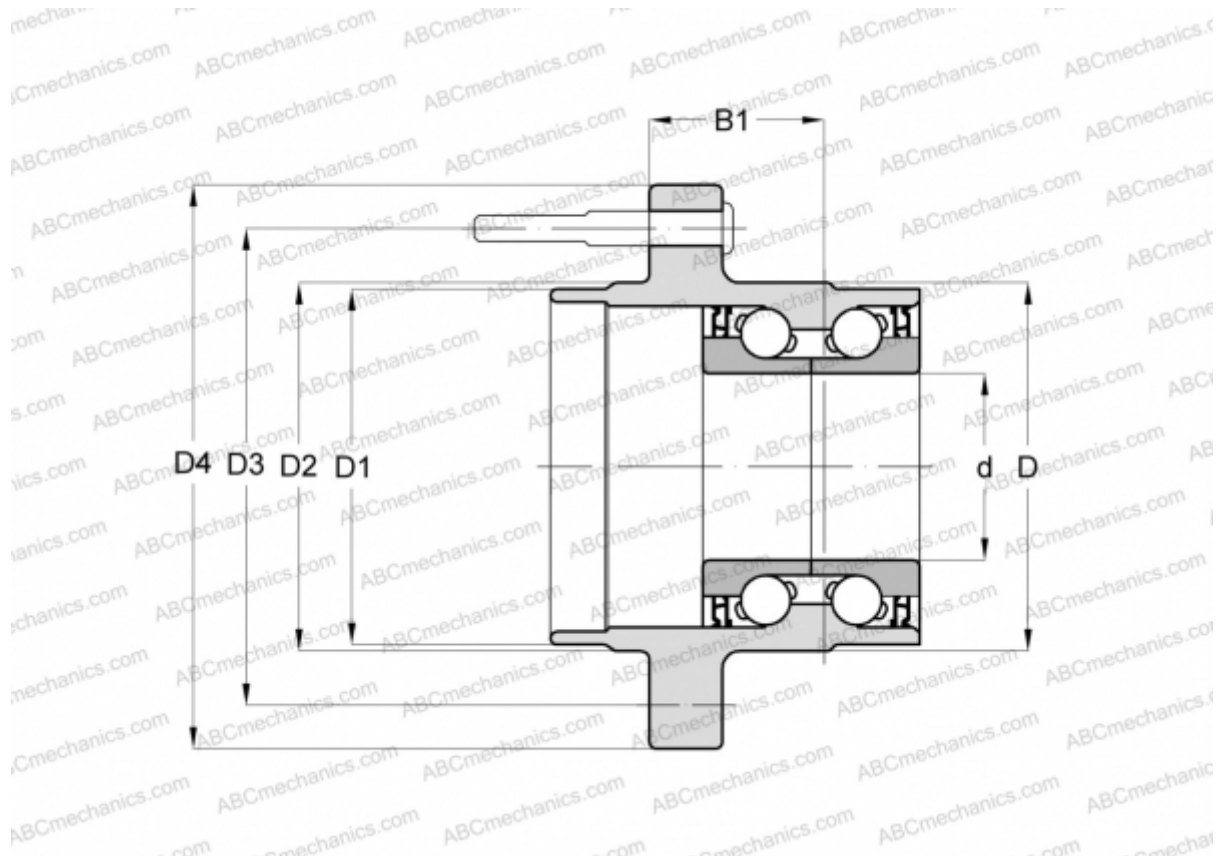

### Technical specification

#### DIMENSIONS, MM

d	32,000
D	80,000
D1	66,400
D2	68,000
D3	114,300
D4	142,000
B1	48,600

#### MANUFACTURER

[FAG](#)