

101622 FAG

Angular contact ball bearings

TYPE: Ball bearings, Angular contact ball bearing, Double row, Hub bearing (unit), FAG production, generation 3

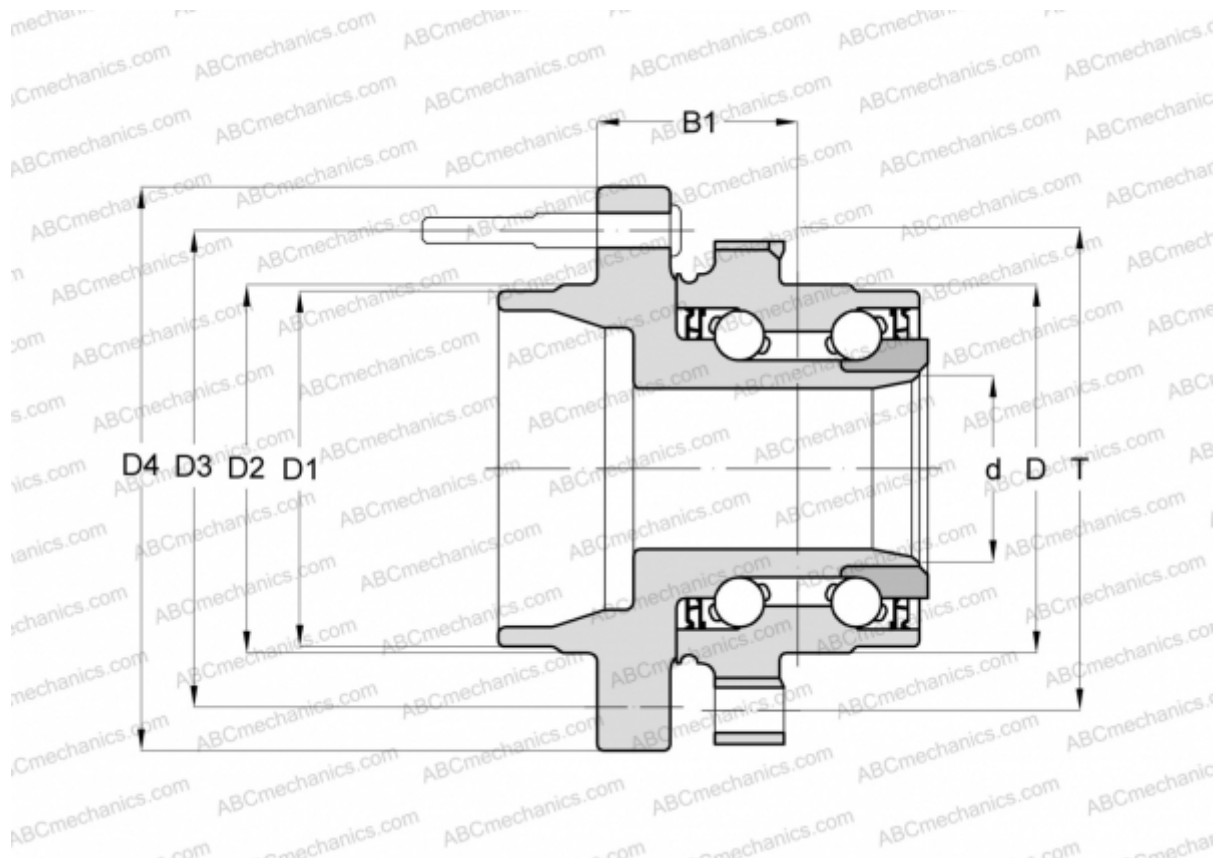

Technical specification

DIMENSIONS, MM

D	80,900
D1	56,000
D2	64,000
D3	100,000
D4	137,500
B1	44,000
T	102,000

MANUFACTURER

[FAG](#)