

101741 FAG

Angular contact ball bearings

TYPE: Ball bearings, Angular contact ball bearing, Double row, Hub bearing (unit), FAG production, generation 3

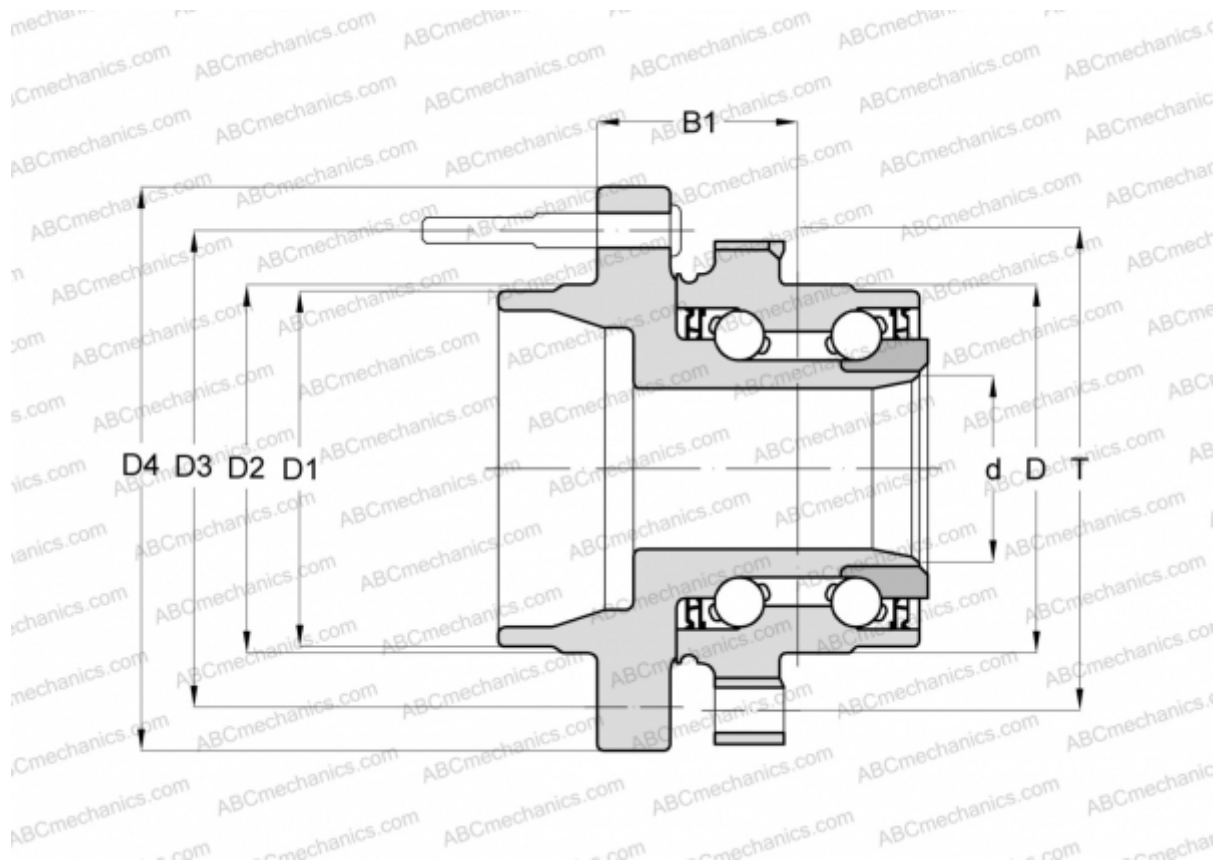

Technical specification

DIMENSIONS, MM

D	81,000
D1	50,000
D2	56,000
D3	100,000
D4	137,500
B1	44,000
T	102,000

MANUFACTURER

[FAG](#)