

101797 FAG

Angular contact ball bearings

TYPE: Ball bearings, Angular contact ball bearing, Double row, Hub bearing (unit), FAG production, generation 3

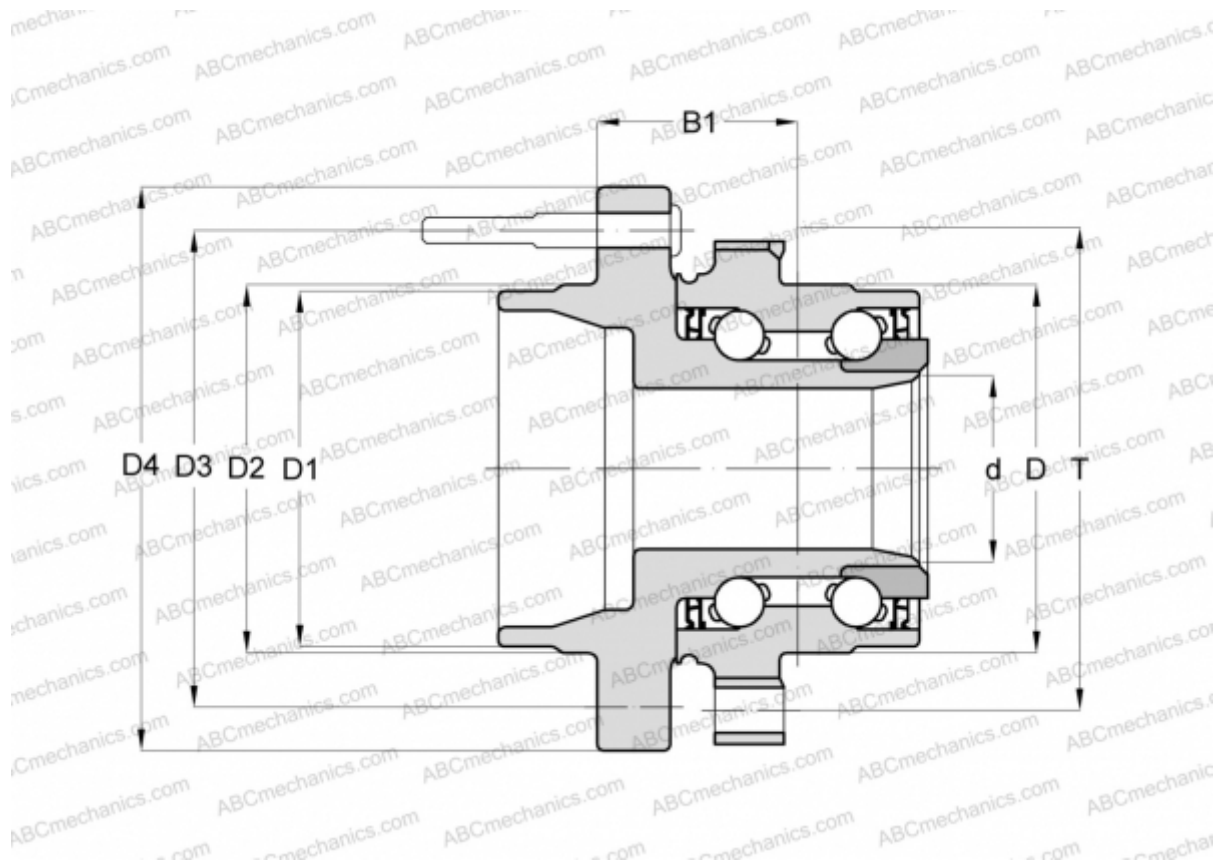

Technical specification

DIMENSIONS, MM

D	90,000
D1	60,000
D2	62,000
D3	114,300
D4	138,870
B1	47,480
T	115,890

MANUFACTURER

[FAG](#)